

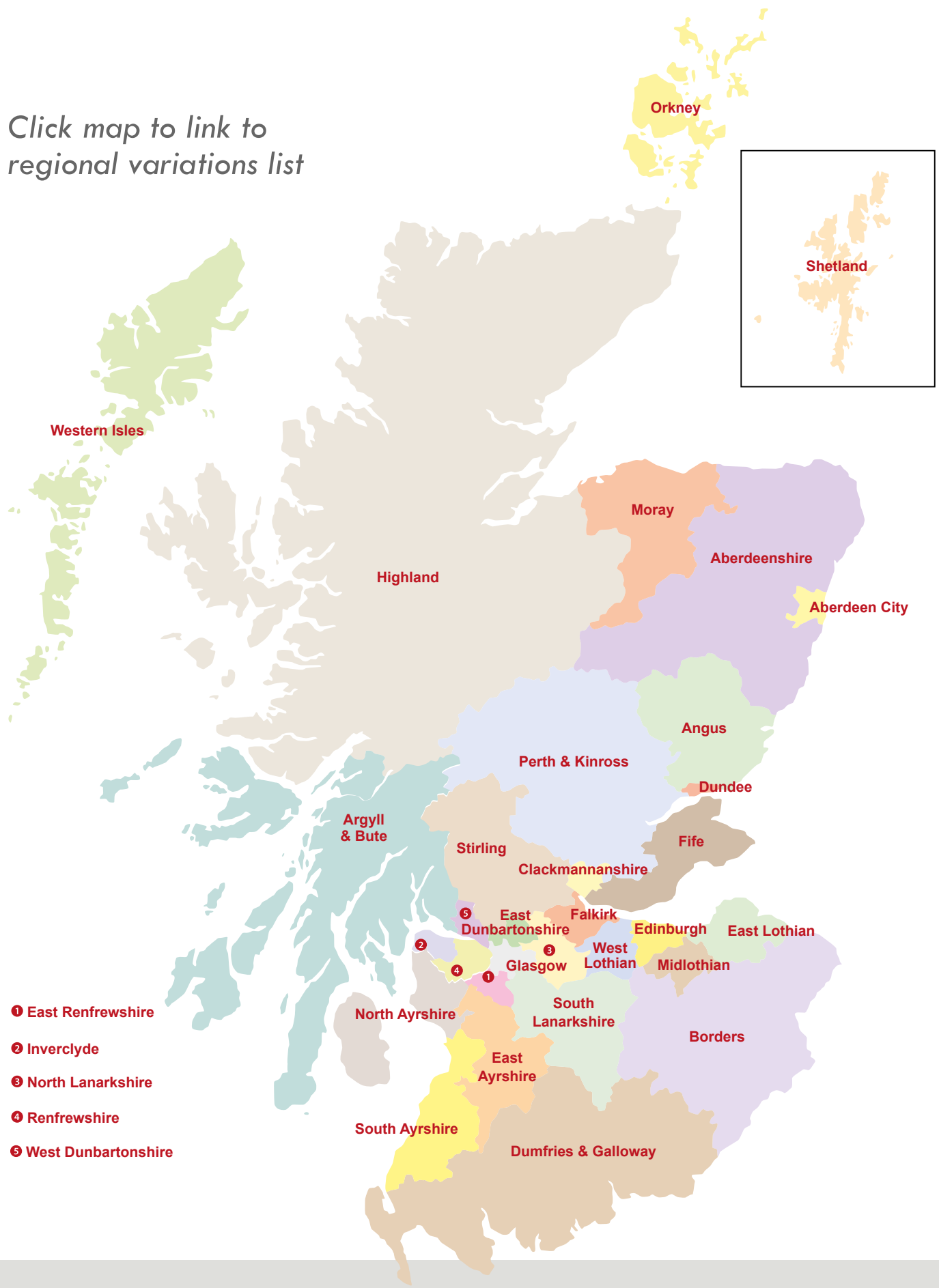

NATIONAL ROADS DEVELOPMENT GUIDE



Click map to link to regional variations list



- 1 East Renfrewshire
- 2 Inverclyde
- 3 North Lanarkshire
- 4 Renfrewshire
- 5 West Dunbartonshire

SCOTS National Roads Development Guide Project Steering Group

John Thomson
Perth & Kinross Council (Chairman)

Ken Aitken
Transport Scotland

Alistair MacKinnon, Rachel Kennedy
Aberdeenshire Council

Tom Rodgers
Aberdeen City Council

Andy Barnes, Graham Harris
Angus Council

Campbell Divertie, Bill Weston
Argyll & Bute Council

Stuart Cullen
Clackmannanshire Council

Ian Cooper, Graeme Alison
Dumfries & Galloway Council

Mike Giblin
Dundee City Council

Kevan Aitken, Stuart Norval
East Ayrshire Council

Gary Blair
East Dunbartonshire Council

Grant Talac, Paul Ince
East Lothian Council

Andrew McBride, Matthew Simpson
City of Edinburgh Council

Craig Russell, Brian Raeburn
Falkirk Council

Richard Simmons
Fife Council

Mic Ralph
Glasgow City Council

John Danby
The Highland Council

David Greenlade
Inverclyde Council

Richard Gerring
Moray Council

Jack McConnache, David Hilditch, Crawford Forsyth
North Ayrshire Council

Jim Johnston
North Lanarkshire Council

Robert McArthur
Renfrewshire Council

Ron Elliot, Derek Inglis
Scottish Borders Council

Colin Gair
Shetland Islands Council



Emma Thomson
South Ayrshire Council

Fraser Jack
South Lanarkshire Council

Jim McGregor
Stirling Council

Robert Smith, Jim Stewart
West Lothian Council

How to use this guide

-  Throughout the guide, this icon will link you to further information.
-  Found at the foot of the pages throughout the guide, this icon will enable you to email any comments or amendments. Please ensure you include the relevant page number.



Click map to see regional variations

This illustration, shown at the foot of the pages, will take you directly to a page where you can access each local authority's variations.

SCOTS have made every effort to obtain permission for the photographs and illustrations contained within this document, however we apologise for any omissions.

Part 1	INTRODUCTION	7
Part 2	PRINCIPLES	25
Part 3	DETAILS	69
Appendices		177

Part 1

ROADS DEVELOPMENT GUIDE





INTRODUCTION

Part 1 - Introduction

Click on the titles to go to that section

1.1 Purpose	9
1.2 Status and Use	10
1.3 Principles and Scope of Documents	10
1.4 The Benefits of Better Streets	13
1.5 Types of Roads and Streets	13
1.5.1 Road Types	14
1.6 Road Network and Context	16
1.7 A Staged Process	21
1.8 The Need for Consultation	22
1.9 Consultation with Other Bodies	22

Introduction

This National Roads Development Guide has been produced by the Society for Chief Officers of Transport in Scotland, supported by Transport Scotland and Scottish Government Planning and Architecture Division.

This document supports **Designing Streets** [🔗](#) and expands on its principles to clarify the circumstances in which it can be used.

1.1 Purpose

The purpose of this document is to:

- ◊ *provide guidance on how to obtain a Road Construction Consent;*
- ◊ *provide a consistent, accessible and relevant source of information that links related detailed and complex infrastructure requirements in one place;*
- ◊ *support the Scottish Government Policy **Designing Streets** [🔗](#) and expand this to address the interface with other roads. This national guide is considered the technical enabler to that policy document.*
- ◊ *advocate a re-designation of road hierarchy to **user hierarchy**;*
- ◊ *support the principles of adopting a multi-disciplinary approach and early engagement to achieve a balanced outcome based on a **user function**;*
- ◊ *accommodate Local Authority variances, such as parking standards or road details. These local departures are intended to be easily identified and accessed and as such form a section appended to this baseline document;*
- ◊ *advocate the creation of a review board and update procedure so that changes to legislation, best practice, codes of practice, guides and other such documents can be regularly included such that the guide is maintained efficiently and will provide a positive long-term legacy;*
- ◊ *encourage high-quality environments that place a focus on people and enable developments to be designed on an individual methodology rather than following standard and rigid specifications where possible;*
- ◊ *support a more holistic, integrated approach to the planning and approvals process with early discussions between all parties actively encouraged.*

1.2 Status and Use

Evidence provided by Transport Research Laboratory (TRL) and TMS Consultancy has updated geometric guidelines for low traffic residential streets including changes to junction spacing, visibility splays and forward visibility. This evidence has a major impact on roads design and is fundamental to altering previously accepted standards with the intention of slowing traffic speeds of compliant drivers

This evidence is adopted in [Designing Streets](#) which provides policy that should be followed in designing and approving all streets. Whilst its technical advice is aimed particularly at residential and lightly trafficked streets, many of the key principles are also applicable to other types of street, for example rural, arterial routes and high streets. As such, this National Roads Development Guide adopts the above evidence led conclusions reached for residential streets and develops this for use on all prospectively adoptable roads.

Note: for the purposes of clarity all streets are deemed to be roads under the [Roads \(Scotland\) Act 1984](#).

The design standard for trunk roads and motorways in England, Scotland, Wales and Northern Ireland ([Design Manual for Road and Bridgeworks \(DMRB\)](#)).

The National Roads Development Guide provides advice and does not set out any new policy or legal requirements.

1.3 Principles and Scope of Documents

[Designing Streets](#) was launched by the Scottish Government to support the placemaking agenda. It raises the importance of street design issues from that of guidance and advice to policy.

It considers that roads within certain environs cater for more important functions than just the movement of people and traffic. To emphasise the different nature of this road type they should be considered as streets. [Designing Streets](#) emphasises that well-designed and well-connected streets are crucial components in sustainable placemaking and sits alongside the 2001 policy document [Designing Places](#), which sets out the role of the planning system in delivering good design and [Scottish Planning Policy \(SPP\)](#).

A locally appropriate balance should be struck between the needs of different user groups. Traffic capacity will not always be the primary consideration in designing individual roads and road layout. However, it is recognised many journeys will still require to be made via vehicular traffic (including buses). As the movement of goods and services is paramount to sustaining and growing a successful national economy, the consideration of movement also remains vital on strategic and rural Scottish routes.

An inclusive environment that recognises the needs of people of all ages and abilities must recognise the importance of way-finding and legibility, especially with regards to the sensory and cognitive perceptions of children, older people and disabled people.

This Guide follows the same principles introduced in [Designing Streets](#) with a change in policy to move away from a standards-based approach to one where designers, planners and roads engineers collaborate to develop a design-led solution.

The key to a successful design is ensuring that the correct balance between place and movement is struck.

Designing Streets [🔗](#) contains five policies:

- 📍 *Street design guidance, as set out in **Designing Streets** [🔗](#) can be a material consideration in determining planning applications and appeals.*
- 📍 *Street design should run planning permission and Road Construction Consent (RCC) processes in parallel.*
- 📍 *Street design should be based on balanced decision-making and must adopt a multidisciplinary collaborative approach.*
- 📍 *Street design must consider place before movement.*
- 📍 *Street design should meet the six qualities of successful places, as set out in **Designing Places** [🔗](#).*

They confirm the fundamental principle that place should be considered before movement, and are supported by 18 key considerations which are outlined in the **Designing Streets** [🔗](#) document and supported by guidance within it.

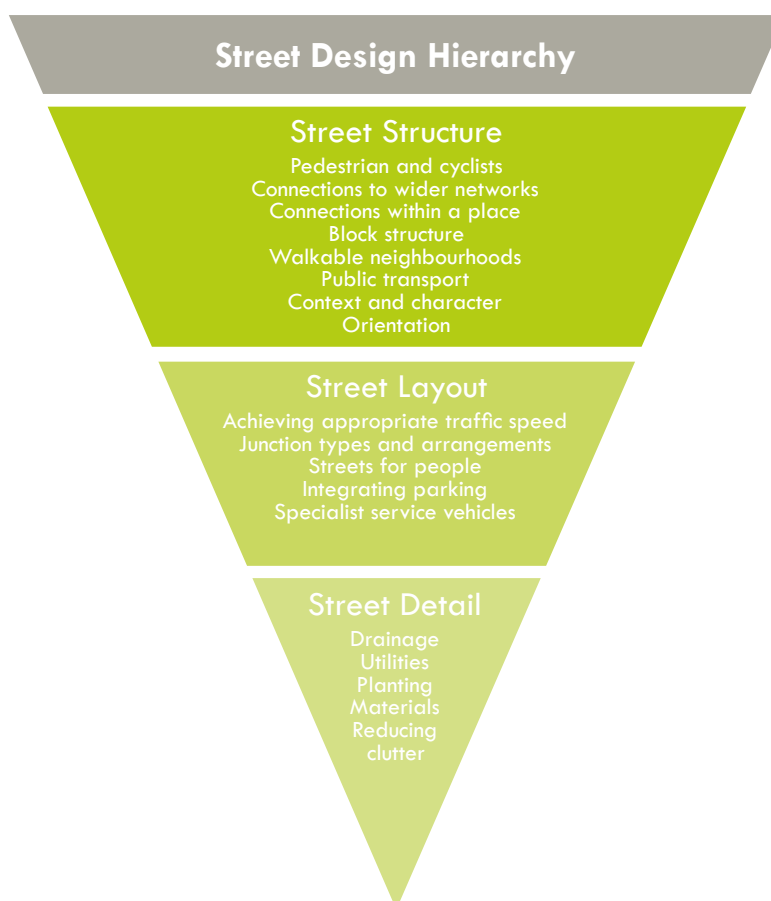

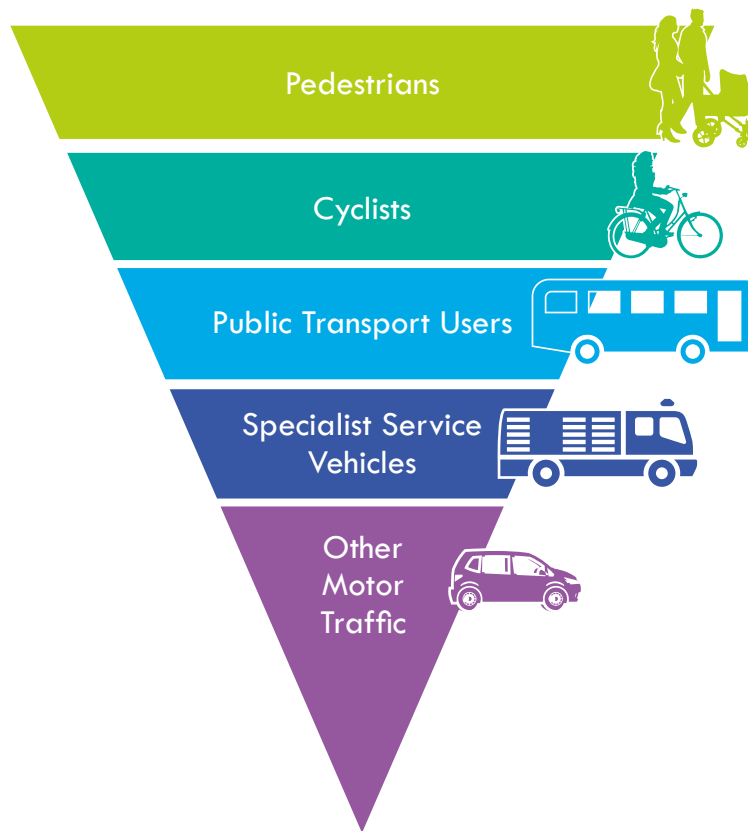

Both documents apply a user hierarchy to the design process with pedestrians at the top. This means considering the needs of pedestrians first when considering the design of any road layout.

Many roads, in both urban and rural locations, require a 'non-standard' approach in response to context and this can be achieved by working as a multidisciplinary team and by looking at and researching other similar places that work well.

In urban areas, it is important to recognise the importance of the community function of streets as spaces for social interaction, and they should integrate communities not segregate them. Consequently, the user hierarchy should be followed and users at the top of the hierarchy should be supported in detailed designs.

Layouts should be designed to restrict vehicle speeds to below 20 mph where there is a high level of place but layouts should create networks which provide permeability and connectivity to main destinations and a choice of routes.

It is intended to move away from hierarchies of standard road types based on traffic flows and/or the number of buildings served and instead design roads which fit the context of the location.

Innovation with a flexible design approach is encouraged as is the use of locally distinctive, durable and maintainable materials.

1.4 The Benefits of Better Streets

It is important to take into account multiple objectives when developing transport strategies and schemes, and not simply congestion reduction. These other priorities include economic regeneration, climate change, casualty reduction, reducing air and noise pollution, minimising the impact of transport on the natural environment, heritage and landscaping, and encouraging more sustainable and healthy patterns of travel behaviour.

Making appropriate provision for road-based public transport, cycling and walking can help to encourage modal shift from the private car, and so contribute to the sustainability and health agendas. Enhancing street environments through a high-quality public realm incorporating local materials and historic street features, removal of clutter and pedestrian barriers, use of shared space where appropriate and enhanced street lighting can help to stimulate local economic activity, reduce street crime and encourage a sense of local community; this in turn encourages more local, shorter distance travel on foot or by cycle.

It is important to include green spaces within these living spaces. Trees are one of the most visible elements of green spaces as their use is considered in more detail in Scottish Government's [Green Infrastructure: Design and Placemaking](#) .

This evidence together with the Scottish Government's commitment that placemaking should be encouraged at every opportunity when development is put forward for planning decisions, requires a completely new approach to road design where new developments or re-development of an area is contemplated. A wide range of other considerations may apply, such as but not limited to: sustainable urban drainage systems (SUDS), waste management, parking, understanding of secure environments, a desire to deliver modal shift from cars to walking and cycling and encourage the use of public transport.

At the outset of design it is necessary to consider the requirements of the wider context of the environment, existing and proposed infrastructure, user needs and related transportation issues. Depending on the development scale this is best demonstrated through the use of flexible masterplanning or for minor developments, a design and access statement.

1.5 Types of Roads and Streets

[Designing Streets](#)  advocates that the former road hierarchy formerly used in previous local authority design guidance be removed to permit a more non-standards basis for street design. Within its section on Street Structure, it contains guidance on how to form networks of streets that are permeable (page 19); responsive to context (page 22); punctuated by squares and public spaces (page 25); and, accommodating of different street character types (page 29).

However, there are a range of minimum design standards required to guide the safe and efficient passage for various types of street users. **A street layout that fails to recognise the street character types and frequency of its users is also likely to fail with regard to the wider structure of the street network.** Any street whilst considering place before movement must balance all associated functions and considerations to deliver a sustainable and adaptable outcome. Much of this is expected to be addressed and demonstrated through a Quality Audit.

Streets that serve a limited number of residential properties are very much a place function and as such can be innovative in that regard. However, they are likely to differ from streets that connect to other areas and as such it is reasonable to assume connecting streets serve a greater movement function. As the connecting function of streets increases towards a main road or primary street they will inevitably carry greater traffic loads over their design life and will require a more robust pavement design as well as the capacity within the road boundary to adapt over time. Consequently it is essential that such streets are not designed on a space limiting basis.

1.5.1 Road Types

In considering the road infrastructure for new developments, **Designing Streets**  can be useful to identify different types of street generally under the following headings:

Primary

- (a) **strategic roads** - provide for major traffic movement between centres of population and economic activity on a national and regional level.
- (b) **main roads or primary streets** - within urban boundaries these link traffic from strategic roads to residential streets or industrial roads. They include 'arterial' through routes and mixed-use, multi-functional 'high streets' (at least in part along their length), providing access to properties as well as other amenities. Likely to be public transport routes they require a careful balance of place and movement when improving or connecting into with new development.

Secondary

- (c) **residential streets** - provide access to properties and through routes within a residential area. As secondary connectors they are much less likely to be public transport routes.

Tertiary

- (d) **residential and service lanes** - solely access to properties within a residential area. These tertiary streets could be mews, vennels, or courtyards.
- (e) **industrial roads** - link multi-functional industrial/commercial premises and associated parking and service areas to main or strategic roads. When within urban boundaries some elements of **Designing Streets**  may be applied, dependent on context and an assessment of future adaptability, but the balance is towards vehicle movement.

Other routes, not for motor vehicles:

- (a) **footways** - a pedestrian route that adjoins a carriageway
- (b) **footpaths** - a pedestrian route not adjoining a carriageway
- (c) **cycleways** - a cyclist route that adjoins a carriageway
- (d) **cycle track** - a cyclist route not adjoining a carriageway
- (e) **shared surfaces** - low trafficked single level street that serves a range of user types, normally limited to residential streets where traffic speeds do not exceed 10 mph.

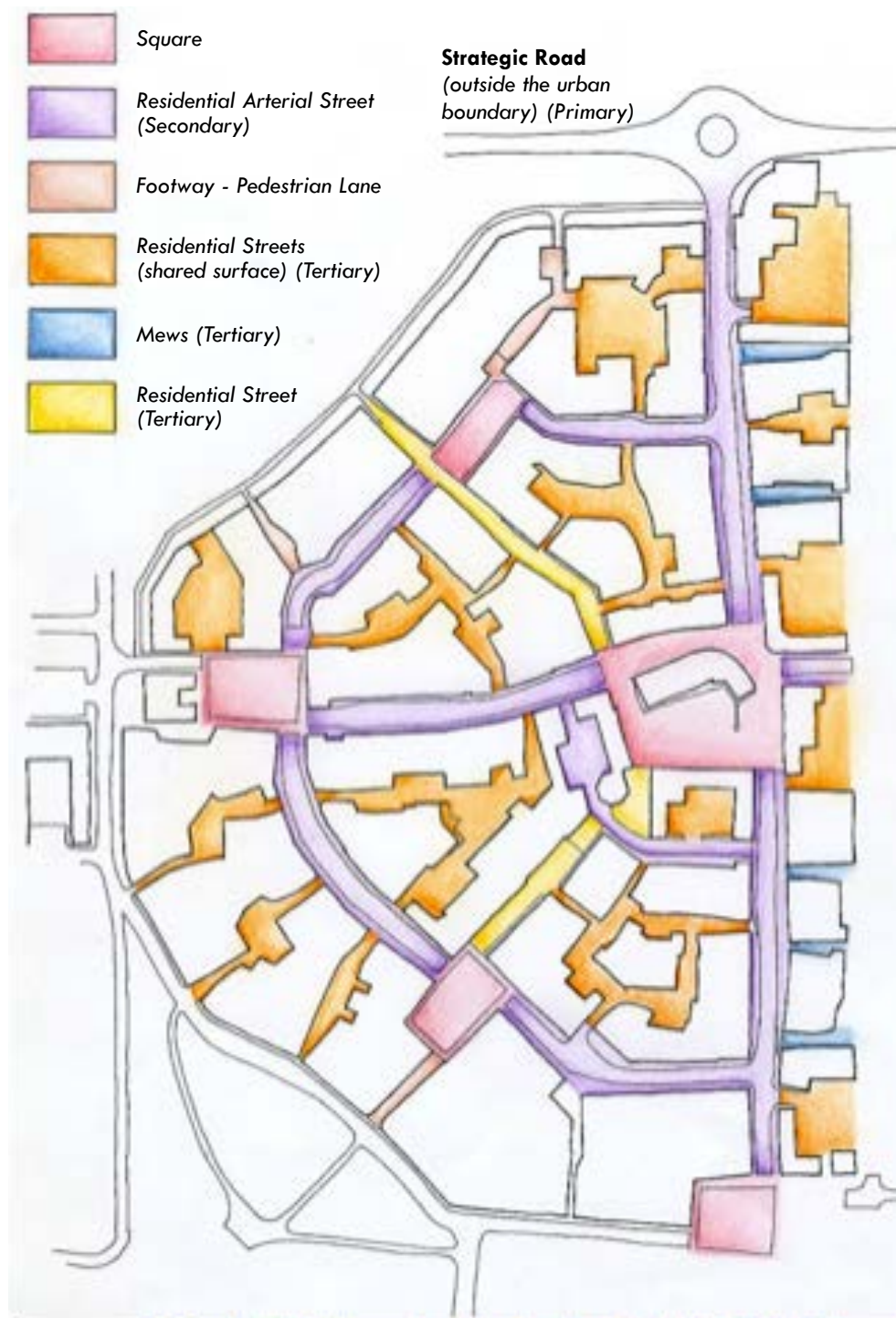

Figure 1

The colouring process illustrated here can be a useful tool in defining streets appropriate for Defining Streets as part of an analysis of function of submitted development proposals, ie [Designing Streets](#) page 21 B-Plans.



1.6 Road Network and Context

To assist designers with the place/movement graph in *Designing Streets* and addressing situations beyond the residential and low trafficked areas that *Designing Streets* predominantly addresses, the graph and illustrations are expanded to reflect all areas and types of roads with an additional indicator of possible appropriate traffic speeds

The plan (shown right) within *Designing Streets* indicating the relationship between *Designing Streets* to DMRB is expanded to assist with identifying arterial and rural roads which may not comply with either standard easily.

The graph on page 9 of *Designing Streets* provides a 'Place and Movement Matrix' diagram.

Place: Place status denotes the significance of a street, junction or part of a street and therefore consideration of **place** is considered critical in the design of good transport networks.

Movement: Movement is activity and can be expressed in terms of traffic volume and strategic importance of the street, or section of that street, it also considers other street users such as pedestrians and cyclists.

To understand the balance between place and movement, the relative importance of the two aspects need to be defined. Some streets will have a high movement status but a low place status, such as strategic or main urban roads. Others will have a low movement status but high place status such as residential streets. In between will be streets such as shopping streets, which are likely to have both high movement and place status.

DMRB only applies directly to trunk roads, but the standard has been adopted on higher speed Local Authority roads where there may be more latitude to depart from these standards at the discretion of the roads authority.

Designers do refer to DMRB and the related *Specification for Highway Works (SHW)* for detailed technical guidance or specification on specific aspects, for example on strategic inter-urban non-trunk roads, but it is recommended that the key principles of *Designing Streets* are applied consistently in a way that respects local context.

Examining the relationship between 'Place and Movement' in a different context it can be seen that there is a relationship between the place and movement matrix and the expected traffic speed.

Figure 2 *Designing Streets* policy and guidance should be applied within all urban and rural boundaries

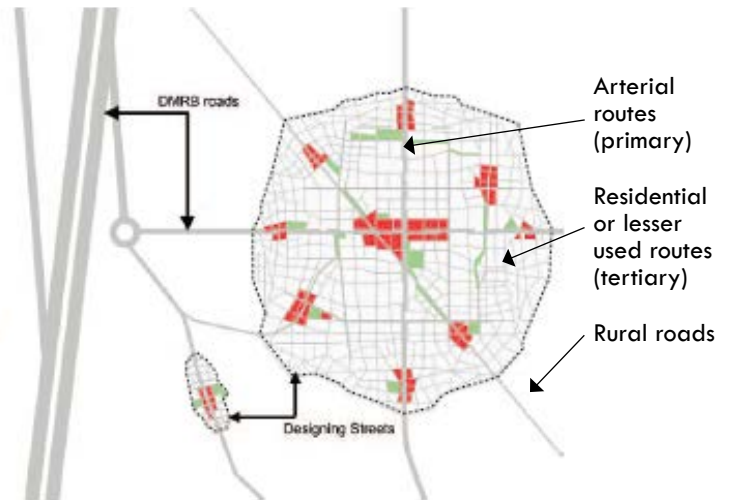
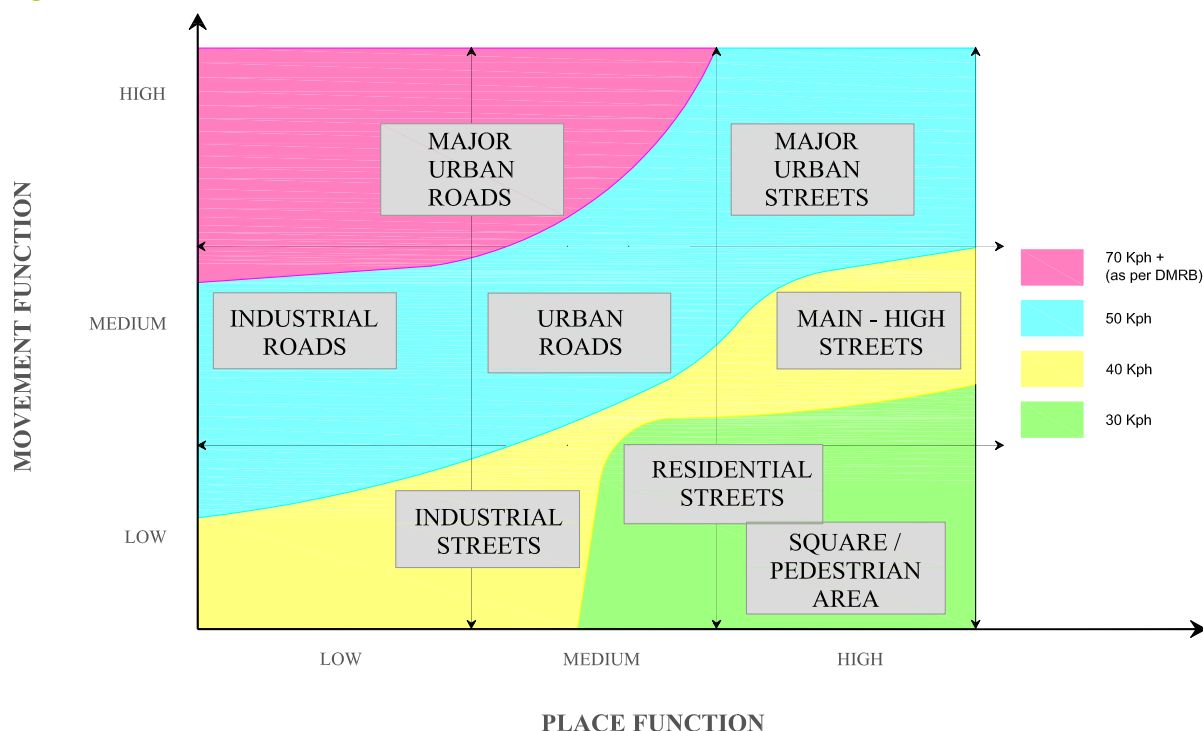

Figure 3



It is clear from this graph that adopting speed may be one way forward to identify where **Designing Streets** [🔗](#) can be utilised. However, there are still many other principles which affect the design and any new design has to take account of local context and even identify where some aspects of *Designing Streets* may be less relevant.



Much of the research utilised in the preparation of **Designing Streets** [🔗](#) is based on the stopping sight distance (SSD) at locations with traffic speeds of less than 40 mph. Similarly, in rural areas many parts of the road network are subject to the national speed limit but have traffic speeds significantly below 60 mph. Generally, in these situations where speeds are lower than 40 mph, evidenced by examination of the 85th percentile, the parameters used in **Designing Streets** [🔗](#) are appropriate.

Town Centres, Commercial/Business areas and Residential areas should be the most walkable part of the network; they should accommodate public transport services, cycle routes and cycle parking, while remaining accessible by service vehicles and private car. Therefore, it is expected that *Designing Streets* applies.

Strategic and arterial routes form essential parts of the wider road network acting as key links between towns, cities and local centres. They can also be part of the core network for the town or city where it is not easy or appropriate to remove or redirect traffic, including HGVs and buses. The level of activity along these links varies depending on location.

Part 1

ROADS DEVELOPMENT GUIDE

Along some sections of arterial routes the movement function will be most important; arterial routes are key to the functioning and economy of urban areas. Strategic and arterial routes within urban areas may have higher speed limits, in these limited cases it may be appropriate that **DMRB**  balance with **Designing Streets**  principles can be adopted for a range of reasons.

Road networks interlace and connect residential, commercial, urban and suburban areas of cities, towns and villages. They fulfil many functions along their routes catering for many types of journey by different modes. Their interrelated nature means that changes to one part of the network can have implications for adjacent routes and therefore must be understood and taken into account when designing and implementing road improvements.

Major routes in the road network are most commonly classified by the volume of traffic they carry and have been known as Principal Routes or Distributor Roads. In the past these standard classifications have remained constant for the whole route. However, by failing to take account of the changing context along the route this classification system limits understanding of how improvements or maintenance should reflect the wider functions such routes serve.

It is also recognised that the local context of place and movement can vary not only from road to road but also along the length of a road as detailed in images below.



Residential



Urban Road



Shopping Area



Strategic Road

This Figure shows that the Movement function remains largely the same along the route, but the Place function varies according to the changing importance of place within the road length; the predominant type of land use and the level of pedestrian activity. As the Place function becomes more important, the relative weight given to the Movement function will be reduced when deciding on priorities and an appropriate design.

Direct frontage access is common in all urban areas, including where 40 mph speed limits apply, without evidence to suggest that this practice is unsafe. This is confirmed in [TD41/953](#) (Annex 2 paragraph A2.10) which states that “in the urban situation there is no direct relationship between access provision and collision occurrence”. However, this is not true of rural roads ([TD41/953](#) A2.5) where the research identified a “statistically significant relationship for collisions on rural single carriageways with traffic flow, link length and farm accesses. On rural dual carriageways, the significant relationship extended to lay-bys, residential accesses and other types of access including petrol filling stations”. Consequently the level of access to the road network is a factor in deciding the appropriate balance of [Designing Streets](#) for busier routes.

A more formal approach to the determination of status level is given to the Place and Movement methodology in the following Table 1. This provides some definitions for different levels of Movement and Place, resulting in a ‘matrix’ defining where it is appropriate to use Design Streets, [DMRB](#) and other variations.

Table 1 identifies where there are significant levels of pedestrian activity associated with the movement of people along the road and this is related to the demand for pedestrians to cross the street. Where there are also high levels of kerbside activity generated by parking, loading and public transport, it would be appropriate to consider that the high level for pedestrian crossings should be utilised.

Four categories are included in the table and definitions of each are detailed below:

- (a) **DS:** The principles of [Designing Streets](#) should be applied.
- (b) **DS BM:** This location is predominantly Place dominated and the general principles of [Designing Streets](#) should be applied. However, there is also a higher level of traffic on these roads and this should be reflected in the design. The design should therefore be pedestrian dominated but the design elements such as road width, visibility, alignment should be less stringent such that vehicles are allowed to travel more freely at a slightly higher speed.
- (c) **DMRB BP:** This location is predominantly Movement dominated and the general principles of [DMRB](#) should be applied. However, there is a higher pedestrian movement at these locations and this should be reflected in the design. The design should therefore allow the free flow of traffic such that drivers realise the change in nature of the road and drive in a more considerate manner.
- (d) **DMRB:** The principles of [DMRB](#) should be applied. Strict adherence to [DMRB](#) is required on trunk roads but departures can be granted on application to Transport Scotland. Local Authority Roads may not require such strict adherence to the design parameters.

Table 1

Movement	Traffic Flows	High	Low	DMRB	DMRB	DMRB	DMRB	DS	DS
			High	DMRB	DMRB	DMRB	DS	DS	DS
			Low	DMRB	DMRB	DS	DS	DS	DS
		Medium	High	DMRB	DS	DS	DS	DS	DS
			High	DMRB	DS	DS	DS	DS	DS
			Low	DS	DS	DS	DS	DS	DS
	Low	High	DS	DS	DS	DS	DS	DS	
		High	DS	DS	DS	DS	DS	DS	
		Low	DS	DS	DS	DS	DS	DS	
				Pedestrians Crossing					
				Low	High	Low	High	Low	High
				Pedestrians Activity					
			Low	Medium	High				
			Place						

Indications of 'Place' can also be given by other uses for example where there are high levels of kerbside activity generated by parking, loading and public transport, it would be appropriate to consider a higher level of 'Place'

The Movement function is defined by a combination of the level of traffic flow and the number of accesses on a particular section of road. It is not intended to define levels of traffic flows as the interpretation will vary depending upon the location within Scotland and where the road serves.

The characterisation of junction spacing within 'Movement' will also be location specific where urban situations will have a higher number of junctions than rural area. The decision whether the number of junctions is high or low should therefore be related to the typical number of junctions for that particular area.

An indication of the status of 'Movement' can also be gained from the actual speed of traffic for existing roads and the proposed traffic speeds for new developments. Where speeds are lower, **Designing Streets**  parameters are recommended. Where there may be some doubt as to which guidance to adopt, actual speed measurements could be undertaken to help recommend a starting point for any design.

This approach demonstrates that the key **Designing Streets**  principles can be applied widely to improve the quality of roads and their application is not necessarily limited to low speed or lightly trafficked routes.

1.7 A Staged Process

The process to be followed is highlighted in the following table that indicates the conjoined approach for both planning and roads construction consent.

Design is a multi-stage process with each stage considering the design hierarchy of [Designing Streets](#): Structure, Layout and Detail.

Early processes define the parameters of the design which must consider the area and scope of the development, uses and trip generation within the defined user hierarchy.

Then how the development links into the wider area has to be considered. This must consider where all the various hierarchical users link into the existing network, considering pedestrians, cyclists, public transport and vehicles. Environmental issues need to be fully understood so that a drainage and green space strategy is efficiently accommodated and all considered for inclusion within the Quality Audit.

Having established the parameters of the development and how it links into the wider area, it is then necessary to undertake a preliminary design. This will consider all aspects of the design at a level that is suitable for submission for planning permission and Stage 1 roads construction consent. This part of the design process will require consultation with planning and roads officials and is likely to be an iterative process until sufficient detail is provided to meet the necessary requirements of both planning and roads authorities.

The penultimate stage allows all elements in the design to be checked for functionality. Some of these technical checks could be conditioned through the planning process. Detailed alterations may still be permissible within the Stage 2 Roads Construction Consent although the first stage should have established enough certainty so that any changes to street design would not require a material change to planning consents.

Following from the checks on functionality, the final design can be completed within the constraints of the planning consent and will allow roads construction consent Stage 2 to be submitted.

This process has been developed to allow the designer to apply for planning permission and Roads Construction Consent concurrently (Figure 4).

Figure 4 Planning and Roads Construction Consent

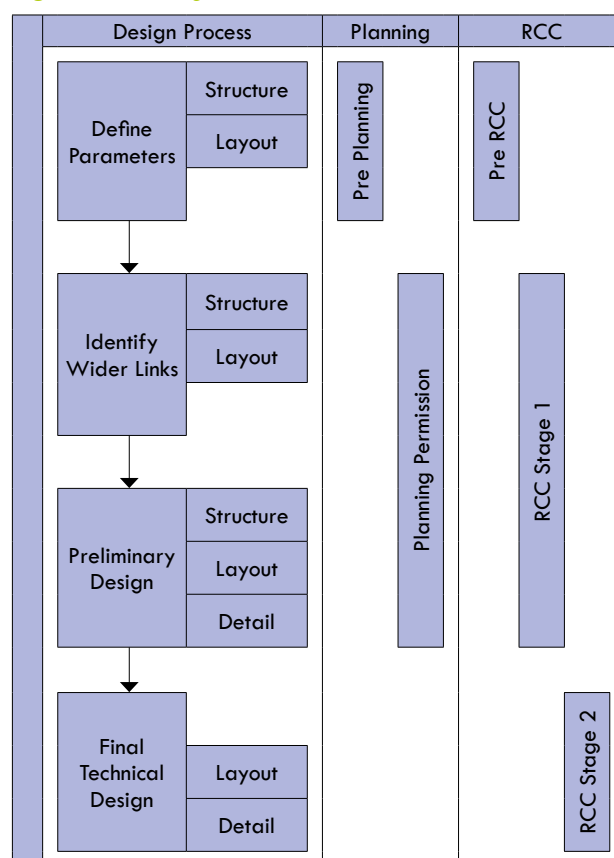

Quality Auditing using the design considerations within this document as well as within [Designing Streets](#)  is encouraged as a method to reach balanced decisions. Further advice on this is provided in the annex tool boxes, together with a quality audit summary template.

1.8 The Need for Consultation

Initial Consultation

It is considered essential to ensure a holistic approach to the planning and the Roads Construction Consent (RCC) processes that developers consult with all officers at an early stage.

Consultation should consider items such as, but not necessarily limited to the following:

- ◊ *the suitability of the location chosen for development in terms of access and/or effect on future roads schemes;*
- ◊ *acceptability of the proposed layout in relation to development control standards;*
- ◊ *a list of the main materials that will be used, and if there are deviations from the materials palette, appropriate approval process;*
- ◊ *the proposed provision of new road structures and alteration of existing road structures (eg bridges, culverts and retaining walls) are subject to **Technical Approval** procedures as outlined in BD2 of the Design Manual for Roads & Bridges;*
- ◊ *Transport Assessment (TA) requirements in support of a planning application;*
- ◊ *drainage and flood risk assessment to identify treatment of surface water discharge and additionally if there is a related flood risk;*
- ◊ *SUDS selection, design and prospectively adopting body;*
- ◊ *Quality Audit, based on the approach set out in this guide;*
- ◊ *officers may be able to advise developers in respect of variations to the specification to suit certain specific local conditions.*

Note: If the issues above are not considered at an early stage, any changes could result in abortive work.

The Developer is required to provide the Roads Authority with completed formal Consultation Certificates included in this guide before Construction Consent can be granted.

1.9 Consultation with Other Bodies

The information contained in these guidelines refers principally to the Local Roads Authority requirements. The requirements of the Planning Authority, Public Transport Unit, Statutory Undertakers, Scottish Fire and Rescue Service, Scottish Ambulance Service, Police Scotland, Scottish Water and Scottish Environment Protection Agency (SEPA) will be extra to these requirements and should be checked out individually at an early stage.

Part 2

ROADS DEVELOPMENT GUIDE





PRINCIPLES

Part 2 - Principles

Click on the titles to go to that section

2.1	Consents	28
2.1.1	Statutory Consents	28
2.1.2	Construction Consent	29
2.1.3	Section 75 Agreements	29
2.1.4	Design Guidance and Adoption Standards	29
2.2	Design	30
2.2.1	Design Context	30
2.2.2	Site Evaluation	31
2.2.3	Street Design Hierarchy	32
2.2.4	Street Structure	32
2.2.5	Street Layout	37
2.2.6	Road and Lane Widths	39
2.2.7	Street Detail	45
2.2.8	Risk and Liability	51
2.2.9	Transport Assessments (Public Transport and Travel Plans plus Quality Audit)	51
2.3	Adoption of Infrastructure	52
	<i>Policy Regarding Adoption and Maintenance (Roads, SUDS, Landscaping (Public Open Space) etc)</i>	
2.3.1	Adoption of Roads	52
2.3.2	Adoption of Parking Areas	54
2.3.3	Housing Courts	54
2.3.4	Service Areas	54
2.3.5	Adoption of Road Lighting and Electronically Controlled Signals etc	54
2.3.6	Adoption of Cycle Tracks	55
2.3.7	Adoption of Cycle Parking, Bus Shelters, etc	55
2.3.8	Adoption of Sustainable Urban Drainage Systems (SUDS) for Roads	55
2.3.9	Pipes and Culverts Under Roads	56
2.3.10	Structures Agreements	57

2.3.11	Road Bonds	57
2.3.12	Delineation Public/Private	58
2.3.13	Dilapidation Surveys	58
2.3.14	Quality Audit including Safety Audit	58
2.4	Application for Construction Consent	59
2.4.1	Responsibility for Design	59
2.4.2	Application for Consent Details	59
2.4.3	Construction Period	61
2.4.4	Amendments to Consent	61
2.4.5	Recycled Materials	62
2.4.6	Road Lighting and Signing	62
2.4.7	Private Signs	62
2.4.8	Road Bond	62
2.4.9	Construction Consent Forms	62
2.4.10	Non-Standard Materials	63
2.4.11	Failure to Comply	63
2.4.12	Inspection Procedures During Construction	63
2.4.13	Applying for Adoption of Development Roads	65
2.4.14	Addition to List of Public Roads	66
2.4.15	Release of Road Bond	66

2.1 Consents

In order to deliver a successful road development proposal in a timely fashion, a range of statutory consents are necessary and are instrumental in guiding the design to an effective and efficient conclusion.

2.1.1 Statutory Consents

The current policy context to the planning approval process is set out in Local Development Plans and the Strategic Development Plans:

(a) **Development:**

Planning Permission in Principle, followed by *Approval of Matters Specified in Conditions*

or

Planning Permission.

(b) **In addition, before any new road construction begins:**

Section 21 of **Roads (Scotland) Act 1984** [↗](#) requires that prior to any work commencing; written consent in the form of a **Roads Construction Consent** is obtained from the road authority.

The *Security for Private Road Works (Scotland) Regulations* may also require a **Road Bond** where appropriate. Refer to paragraph 2.3.12.

It should be noted that the granting of *Planning Permission* does not necessarily imply the granting of *Roads Construction Consent*. Additionally it is an offence to work without addressing these consents. **SCOTS Guide for the Road Construction Consent and Road Bond process** [↗](#).

It should be noted that the granting of *Detailed Planning Consent* does not relieve the developer of the requirement, in terms of Section 21 of the **Roads (Scotland) Act 1984** [↗](#), to obtain *Construction Consent* from the Local Roads Authority for permission to construct new roads.

(c) **Work on the existing public road (Road Opening Permits):**

Where any work either on the existing public road is to be undertaken or if works are undertaken adjacent to the existing public road that imposes for any reason onto that public road written consent, under **Section 56 of the Roads (Scotland) Act** [↗](#) from the Roads Authority is required. Please note: the Road Authority may require technical approval, similar to RCC requirements, as a condition of S56 approval.

The Road Authority may enter into a Section 48 agreement for Contributions towards expenditure on constructing or improving roads.

Additionally, where these works require the placing and maintenance of apparatus in a road that imposes for any reason in or under that public road, written consent under **Section 61 of the Roads (Scotland) Act 1984** [↗](#) from the Roads Authority is required.

*Developers should note that applications for the granting of statutory consents require significant lead-in times as they may involve a range of technical procedures, consultations and processes to be completed prior to submitting an application. **The developers are strongly advised to make allowance for this in their project management plans especially where they have known key deadlines.***

(d) **Construction of a New Access from a public road:**

Where construction of a New Access is taken from a public road, written consent detailing the standard of works together with any reasonable conditions from the Roads Authority is required.

2.1.2 Construction Consent

In terms of Section 21 of the **Roads (Scotland) Act 1984** [↗](#), any person other than a Roads Authority who wishes to construct a new road or an extension (including lateral widening) to an existing road must obtain Construction Consent, irrespective of whether or not such roads are to be submitted for adoption as public. It is an offence under this Act to commence any construction of a road prior to obtaining Construction Consent. Construction Consent is granted by the Local Roads Authority and road construction works may only be undertaken while the Construction Consent (Form CC1) remains valid.

2.1.3 Section 75 Agreements

For infrastructure improvements outwith the development site deemed necessary by the Local Roads Authority, the Developer may be required to enter into a Section 75 Agreement Under Town and Country Planning (Scotland) Act 1997 [↗](#) **with the planning authority.**

2.1.4 Design Guidance and Adoption Standards

Construction Consent should be granted only where proposals for the layout and construction of roads, structures, road drainage and lighting meet the guidance as detailed in this document and any variations permitted by the Local Authority. Within an urban situation the balanced approach contained within **Designing Streets** [↗](#) to design means any 'standards' for street structure, layout or detail must be considered in context and the guidance within this document should be used to influence specific aspects or elements of the street design.

6 or more individual dwellings should normally be served by a 'road' which will require Construction Consent and the submission of a Road Bond in a residential area.

Generally 5 or fewer dwellings (more if a 'brownfield site', eg redeveloped farm steadings) will be served by a 'private access' which, as there is no right of public access, will not require Construction Consent and will not be available for adoption. Such layouts should provide adequate turning facilities and a satisfactory junction with a public road. The provision of a 'private access' must be indicated clearly at the planning application stage, otherwise it will be considered that a 'road' is being provided.

2.2 Design

2.2.1 Design Context

This guide reflects **Designing Streets** [↗](#) as the policy statements for street design in Scotland in that it does not pursue a standards-based approach and is determined heavily on a user-based approach.

Roads or Streets are key determinants of rural and urban character respectively and along with economic viability their treatment must seek to create harmonious relationships between the road, building and landscape as well as function. Successful design requires that the functioning of all the various elements are considered together, eg the road itself, buildings and utility servicing, pedestrian areas, open spaces, drainage systems and parking layouts as well as gardens and play areas in residential areas, with the aim of creating a safe, connected and attractive environment for and all users.

Adopting a comprehensive approach it is more likely to produce an acceptable design. This Guide describes methods by which the policy can be more consistently applied.

It is critical that at the earliest stage the designer understands all the requirements of supporting civil infrastructure and using this knowledge creates a functional layout to meet requirements by balancing all decisions to that end.

The six qualities identified in **Designing Places** [↗](#) and referenced in *Designing Streets* to create successful places are:

- ◊ *distinctive;*
- ◊ *safe and pleasant;*
- ◊ *easy to move around;*
- ◊ *welcoming;*
- ◊ *adaptable;*
- ◊ *resource efficient.*

A good practice would be to use the key considerations, explained in more detail in **Designing Streets** [↗](#), as a checklist to judge a proposed layout against and thus ensure compliance: refer to Quality Audit section.

An integrated and balanced approach is necessary for the design of new development layouts, such that all factors are co-ordinated to give a final result which creates a pleasing and attractive environment, enhances the community function and is not an excessive drain on community resources.

The layout design is required to balance a range of essential considerations and elements in developing an acceptable road layout and therefore **a sense of place**. **Note:** *A designer who uses minimum road standards is likely to swing the balance towards movement rather than place and this approach is not acceptable for streets with a higher place function.*

These elements may consist of but are not limited to traffic flows, design speed, needs of all users including pedestrians and cyclists, the young and the elderly), place, movement, function, dwellings or adjoining buildings, road widths, forward sight lines and integration of SUDS.

This guide supports methods of Sustainability and encourages resource efficiency in all aspects of construction, management and maintenance of Infrastructure.

2.2.2 Site Evaluation

Before starting a site layout design it is important that an analysis is carried out of the existing assets and constraints of the site which will have a bearing on the layout or treatment of the road. Issues to be considered include:

- *existing road layout* - to assist with design and connections to the existing road and path network;
- *intended road function* - to help determine factors such as the geometry, scale and detailed treatment of the road;
- *potential for future adaption* - links function or potential function to road geometry;
- *existing structures (buildings, retaining walls, fences, signs, historical artefacts etc)* - to take protection measures and guide the design;
- *established patterns of use* - identifies traffic patterns and informs traffic management needs or guides alternative provision for all uses;
- *significant buildings or public open spaces* - to identify potential areas for environmental enhancement and desire line traffic management;
- *key views to and from the area* - to enhance important views and identify areas for screening;
- *drainage and consideration of natural flow paths* - any site layout must ensure that rainfall that exceeds the capacity of drainage systems has minimal impact upon new infrastructure. Flow paths that lead to property flooding or to critical roads being inaccessible are not acceptable.

For guidance that covers topography and natural features items, Scottish Government's **Green Infrastructure: Design and Placemaking** [🔗](#) should be referred to:

- *topography* - identify design constraints and assist with the alignment of new roads and location of drainage systems;
- *hydrology* - to assist with defining the SUDS selection and design;
- *street trees* - identifying existing to be retained or provided to enhance public space considerations;
- *significant flora and fauna habitats* - to protect and enhance features of ecological importance.

Following site analysis then the design team, with the architect or master planner working in tandem with infrastructure designers, engineers and landscape architect should work through the design aspects or building blocks of street design, roughly as the hierarchy set out in **Designing Streets** [🔗](#).

2.2.3 Street Design Hierarchy

The pages that follow use the same aspects of design as **Designing Streets** [↗](#) and are noted, for ease of reference, in the same order as the policy document. The triangle contains links to the relevant page of guidance within *Designing Streets* each aspect refers to. Table 2 opposite is adapted from the table in *Designing Streets* showing how each aspect of street design links to the Six Qualities of Successful Places.

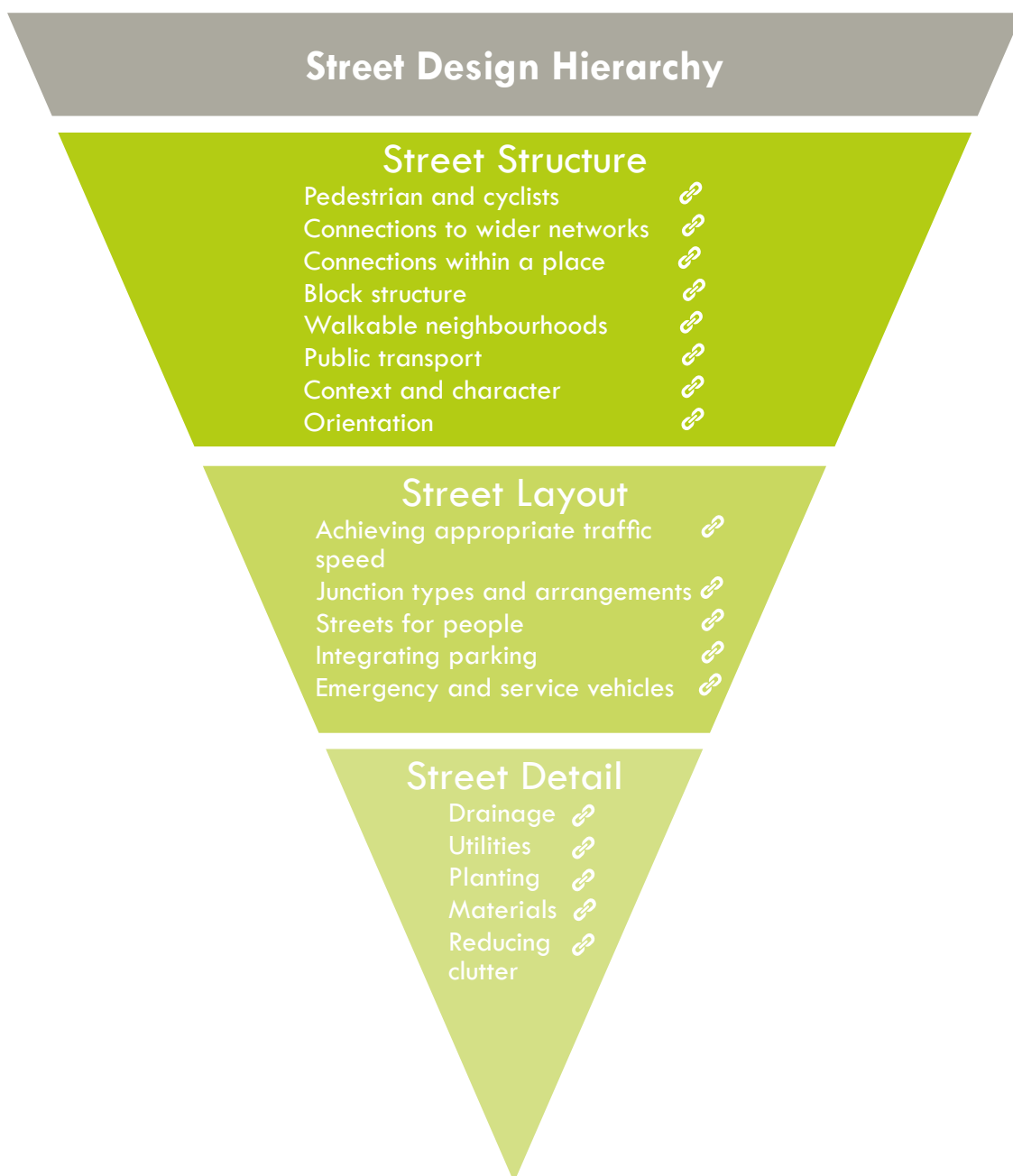



Table 2 *The Six Qualities of Successful Places: Key Considerations for Street Design*

<i>distinctive</i>	<i>safe and pleasant</i>	<i>easy to move around</i>	<i>welcoming</i>	<i>adaptable</i>	<i>resources efficient</i>
Street design should respond to local context to deliver places that are distinctive	Streets should be designed to be safe and attractive places	Streets should be easy to move around for all users and connect well to existing movement networks	Street layout and detail should encourage positive interaction for all members of the community	Street networks should be designed to accommodate future adaptation	Street design should consider orientation, the integration of sustainable drainage and use attractive, durable materials that can be easily maintained
Block structure Context and character	Pedestrians and cyclists Achieving appropriate traffic speed Reducing clutter	Connections within a place Public transport Junction types and arrangements	Walkable neighbourhoods Streets for people	Connections to wider networks Integrating parking Service and emergency vehicles	Orientation Drainage Utilities Planting Materials

2.2.4 Street Structure

(a) Pedestrians and Cyclists

Developments can take a variety of forms, with different requirements both internal and external to the site. The designer must therefore examine the user hierarchy in the proximity of the development to ensure that relevant design standards are achieved and that the needs of all road users are met, especially the requirements of pedestrians, cyclists, public transport and disabled users.

Designing Streets  identifies a change to mode hierarchy for residential and low use street with pedestrians having greatest consideration. Consideration of pedestrians and cyclists first means that conditions should be reviewed to determine whether changes can be made to volume, speed and road space provided to other traffic, before segregation and formally defined at-grade crossings are provided.

This user hierarchy is endorsed by this guide for strategic and main roads also. If developments are to meet the needs of pedestrians and cyclists and establish those as the preferred modes of travel within a new neighbourhood, the design of infrastructure must be focused, firstly on those needs. The removal of the requirement for a traditional roads hierarchy and the introduction of this National Road Development Guide provide designers with the freedom and flexibility to produce layouts that take full cognisance of the mode hierarchy.

Where a combined cycle and pedestrian route is proposed reference should be made to Transport Scotland's [Cycling by Design](#) and [LTN 1/12 Shared Use Routes for Pedestrians and Cyclists](#) to assist with design guidance.

(b) Connections to Wider Networks

To meet the objectives outlined in this guidance, developments need to be well connected to their surroundings. It is acknowledged that the provision of multiple access points has implications on the amount of land available for development, but to create quality neighbourhoods a balance needs to be struck.

It is important to note that the number of vehicle accesses into a development should not preclude the provision of additional, high-quality pedestrian, cyclist or public transport only accesses via footpath, cycle track or bus-only links.

A key aspect of connectivity is adaptability and to consider connections for future adjacent developments without leaving ransom strips. An outward looking block structure by necessity considers development edge treatment, which permits future adaption readily.

Developers are recommended to work with Local Authority officers to ensure their proposals are well connected as part of a strategic approach to the transportation network.

The existing road network must be capable of coping with the existing as well as levels of all types of traffic generated by the development. The road and paths created within a development must connect into the existing road and other user networks in a logical and progressive manner.



The extent of a proposed development may require existing routes for vehicular traffic as well as pedestrians or cyclists to be assessed to ensure that the traffic generated by the new development does not exceed the road capacity. Where a **Transport Assessment** [↗](#) identifies a need for additional traffic management, particularly to a strategic or main road, the resultant design requires early and detailed consultation with the road authority to develop proposals. Where any requirement to mitigate the effect of the development on adjoining roads is identified, the developer will be required to fund appropriate remedial measures as a part of their development that could be for vehicles but equally could be for higher pedestrian use such as new or improved controlled crossing points.

(c) Connections within a Place

Permeable layouts make navigation through developments simpler and easier and reduce frustration. They shorten distances and increase the attractiveness of walking and cycling as preferred modes for certain journeys.

Policy states that street structure should be connected and permeable, as such the use of cul-de-sac layouts is strongly discouraged. An alternative layout to address infill sites could consist of a courtyard development which provides a good sense of place as well as limits the scale of such a street network. Refer to **Designing Streets** [↗](#), page 19.

(d) Block Structure

The block structure readily enables a range, variety and choice of desire lines for all road user modes as well as addressing adaptability. Grid structure patterns traditionally sit comfortably alongside strategic or main roads.

Roads bordering the rear of housing areas enclosed by high boundary fences to provide private rear space result in unattractive isolated and unsecure links. A multi-function courtyard approach can greatly benefit this design aspect.



(e) Walkable Neighbourhoods

Good connectivity to surroundings should enable access to shops and services outwith the development. However, within the development there is still a need to ensure that movement can flow through the development creating places in their own right.

(f) Public Transport

Public Transport routes must be positively identified at the outset of a development and provision made prior to private transport plans being established and adopted by those moving to the new development. The potential for bus penetration within large developments to give convenient accessibility should be highlighted within any Transport Assessment report.

Good public transport provision should be available at the initial phase of any new development, either by linking to existing networks or by establishing new routes and should therefore be discussed with local transport operators at an early stage.

All details in relation to the provision of bus stops and related infrastructure requirements should be obtained at an early stage by consultation with the Roads Authority's Transportation Manager or nominated representative.

(g) Context and Character

When assessing the potential visual impact of new development, designers should work within the context of broad urban design aims, taking cognisance of such aspects as the existing character and qualities of urban design, architecture and landscape of the area, historical patterns of development and social and cultural factors which impact on the environment. National planning policy contained in [Designing Streets](#) and [Designing Places](#) illustrates how these issues may be addressed in a comprehensive way to help create development which contributes to local identity and enhances the sense of place. This National Roads Guide describes methods by which the policy can be more consistently applied.

(h) Orientation

Refer to page 31 of [Designing Streets](#) for the principles of guidance on how streets should be orientated to maximise the benefits of sun and wind, elements of the micro-climate of the place that should be considered also by the roads engineer in the positioning of more technical elements of design.

2.2.5 Street Layout

Achieving Appropriate Traffic Speed (Pages 32-35 of [Designing Streets](#))

(a) Low Use and Residential Streets



This section that covers the principles of design speed is a vital area where engineering input at an early stage can help to create a balanced solution that takes account of the safety of all road users and the crucial factor of driver behaviour. **Transport Research laboratories report TRL 661** [↗](#) notes that, in their study, the largest effect on speeds was found to be associated with reduced lines of sight.

New developments are recommended not to use vertical traffic calming features such as speed cushions and humps as these may have detrimental effects on disabled and infirm road users. However, vertical traffic calming features such as raised tables at junctions may be suitable in new low use residential developments. Wherever possible, slower speeds should be promoted through other road alignment.

Methods of reducing vehicle speeds include (findings from **TRL 661 Report** [↗](#)):

- *reduced forward visibility (reduced forward visibility from 120 m to 20 m = 20 mph on links and 11 mph at junctions);*
- *narrower lane widths (5 m wide road = 4 mph on links, approaching junctions = 10 mph);*
- *shorter block lengths (see forward visibility);*
- *block paved or setted road surfaces (= 5 mph reduction);*
- *presence of on-street parking features within the carriageway (=2 mph to 5 mph - CAUTION aim for off-street or reduce interaction with pedestrians - near miss concern).*
- *informality in street and junction layout.*



Since each method has different impacts in speed, clear understanding of each type of speed reducing element and what impact it can have is expected from the designer rather than a simplistic assumption of effect.

(b) Strategic, Arterial or Roads Serving Commercial and Industrial Use

Due to the detrimental effect vertical traffic calming techniques, such as speed bumps, has on disabled or infirm passengers its use is limited and restricted to residential areas, the use of this on other types of roads requires detailed substantiation and consultation with the Local Authority in advance. The proposed use of such vertical traffic calming measures in the vicinity of hospitals and such establishments is unlikely to be supported.

Street layout information within **Designing Streets** [↗](#) identifies acceptable SSD values for both x and y terms for cars and light vehicles. This section gives guidance on Stopping Sight Distance (SSD) for streets where 85th percentile speeds are up to 60 Km/h (37mph), this will generally be achieved within 30mph limits with the potential to be achieved within 40 mph limits. The SSD, the distance drivers need to observe and stop within a given speed, includes the perception and reaction time. For new streets the designer sets the design speed but on existing streets the 85th percentile, wet weather speed is used. It is important to note that the updated SSD values are appropriate for cars and light vehicles but bus and HGV have different deceleration characteristics.

(c) Rural Areas

In rural areas not subjected to local speed limits, **TD9/93** [↗](#) is taken as a starting point for new routes which aligns design speed to the Alignment Constraint (bendiness and sight distance) and

Layout Constraint such as determined from carriageway width, verge width and junction and access frequency. It is essential that the designer understands the concepts of road width and forward visibility to reduce traffic speeds into the overall design of a scheme to ensure that appropriate speed levels conducive to road safety are evidenced and designed into proposals.

2.2.6 Road and Lane Widths

Whilst not a specific aspect of design within DS, this guide goes into more depth on the subject of widths of carriageways as part of an overall layout.

This guide is not as prescriptive as previous versions of Roads Development Guides regarding road widths; this is specifically to enable a designer to select an appropriate road treatment in keeping with the placemaking and design concept. Where the movement function is high, a range of minimum standards associated with a roads function will be identified to assist designers.

There are also a number of locations where the road will change its function and as such it is possible that the design parameters will change along the length of a road and it is essential that the designer understands the parameters used for place and movement to understand the standards which must be followed. These parameters are explained in more detail in Part 1.

It can also be seen that even on roads where either place or movement dominates the designer's thinking there can be changes to the balance between them and the road design should alter to reflect locations where the balance moves between the two parameters.

However, user requirements are considered critical in the road design and the use of swept path analysis to provide evidence in support of proposed road width and other design factors are considered critical in support of a proposal. Swept path analysis, or tracking, is used to determine the space required for various vehicles and is a key tool for designing carriageways for vehicular movement within the overall layout of the street. The use of this technique often proves to be beneficial in determining how the street will operate and how vehicles will move within it.

Layouts designed using a high 'place' function should be designed to enable buildings to be laid out to suit the character of the street, with footways and kerbs helping to define and emphasise spaces. Designers have the freedom to vary the space between kerbs or buildings. The kerb line does not need to follow the line of vehicle tracking if careful attention is given to the combination of sightlines, parking and pedestrian movements.

Every road needs to be designed to match its place and movement function, but it must also be capable of coping with the types of traffic and other maintenance events. All types of traffic using a road require to be able to manoeuvre along the road while not adversely impacting on the place function and must remain safe for the road users. Refer to 3.1.3 for details.

This should not be interpreted in a manner where roads widths in areas with a high 'place' function are designed for the movement of occasional HGV traffic as the use of the road by vehicles such as waste management vehicles, as clearly their use is minimal. Refer to Emergency and Service vehicle provision, page 44 of [Designing Streets](#) .

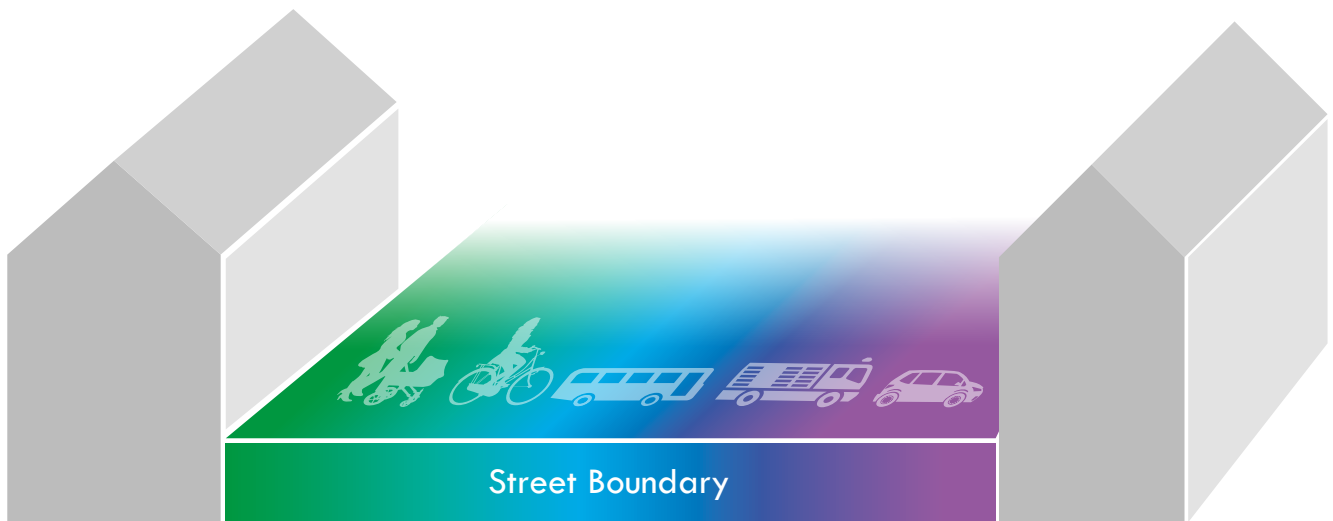

When allocating dimensions for road boundaries a number of criteria need to be considered, which includes both vehicular and non-vehicular/pedestrian demands; current and potential future requirements of the infrastructure and the impact different drainage methods would have on the design.

Traffic congestion impacts on air quality and as a result place quality. Where traffic assessment figures indicate a traffic volume in excess of 10,000 Annual Average Daily Traffic (AADT) advice is required from the road authority regards minimum road widths. Where cycle lanes are provided and specifically on a strategic or main road, a minimum allowance as detailed in [LTN 2/08 Cycle Infrastructure Design](#)  should be made to permit safe overtaking.

The design process to be followed should be to progressively build up the road width by creating 'lanes' to meet the requirements of all road users. An effective understanding of this system permits the designer latitude to develop a road with adequate facilities to suit the location and the place function while ensuring that the overall final design is safe and adequate for movement. In essence, the 'lane' width and therefore road width is built up within the design based on User Requirements.

The requirements of each of the roads users is detailed below, while remembering that the road is made up of elements for vehicles, both motorised and non-motorised; pedestrians and other areas for parking, landscaping and 'place' functions. Incorporating SUDS, trees, street furniture or other such aspects become straightforward to include in the overall design. Due regard for disabled users is required.

One of the six qualities of successful places is 'adaptability'. The design of a road, particularly strategic roads, using the above lane analysis will identify a minimum road width readily. However

the resultant creation of 'the Road' between property boundaries has a permanent effect of defining public space. Careful consideration needs to be given to this regards future integration within the overall context of the area.

(a) Junction Types and Arrangements

Pages 36 to 37 of [Designing Streets](#) indicates a range of junction types and arrangements. Research provided by [TRL and TMS Consultancy](#) has updated geometric guidelines including changes to junction spacing, visibility splays and forward visibility. The immediate effect changes road layout design substantially, over former understandings, permitting more traditional layouts in urban areas. For detailed understanding of visibility at junctions, reference to [Designing Streets](#), [Manual for Streets](#) and [Manual for Streets 2](#) is strongly recommended. Reduced sightline requirements at residential road junctions, based on evidence to reduce speed, permits tighter corner details. Junctions are an integral aspect of any development design and are critical as they influence the inclusion of larger public spaces such as squares and meeting points as well as deal with traffic conflicts.

(b) Streets for People

Page 38 of [Designing Streets](#) describes how streets are about places of activity where people of all ages can interact as well as provide for the movement of motor vehicles. This tendency to favour co-operative rather than segregated streets referred commonly as a shared spaces require careful consideration regards the design and creation.

(c) Shared Surfaces

Shared Surfaces are areas where streets are shared between pedestrians, cyclists and all motor vehicles. This technique is normally restricted to areas where vehicle speeds and volumes are demonstrably low so an environment is created in which all road users have equal priority within the street. Particular regard must be given to disabled users. Reference to [Sight Line](#) is encouraged to support such applications.

Community courtyards, contained within a block structure layout readily provides for shared surfaces and amenity space, these areas should be designed for low traffic speed and volume and can address waste management, utilities and SUDS (Figure 5).

Shared surfaces normally contain street furniture or planting, to add to the sense of place and assist in keeping vehicle speeds to appropriate levels. However, shared surfaces can also be used in high street and other pedestrian dominant environments to reinforce the user hierarchy.

Note: An audit of such areas which indicates clear regard and consideration to disabled users and equalities legislation during design is required to support such street proposals. Additionally, designers are required to provide a holistic understanding of these areas which not only address layout and equality requirements but underground servicing also: refer to Quality Audit. It is recommended that underground utilities are considered at an early stage and maintenance access together with reduced pavement disruption is designed in.

Figure 5

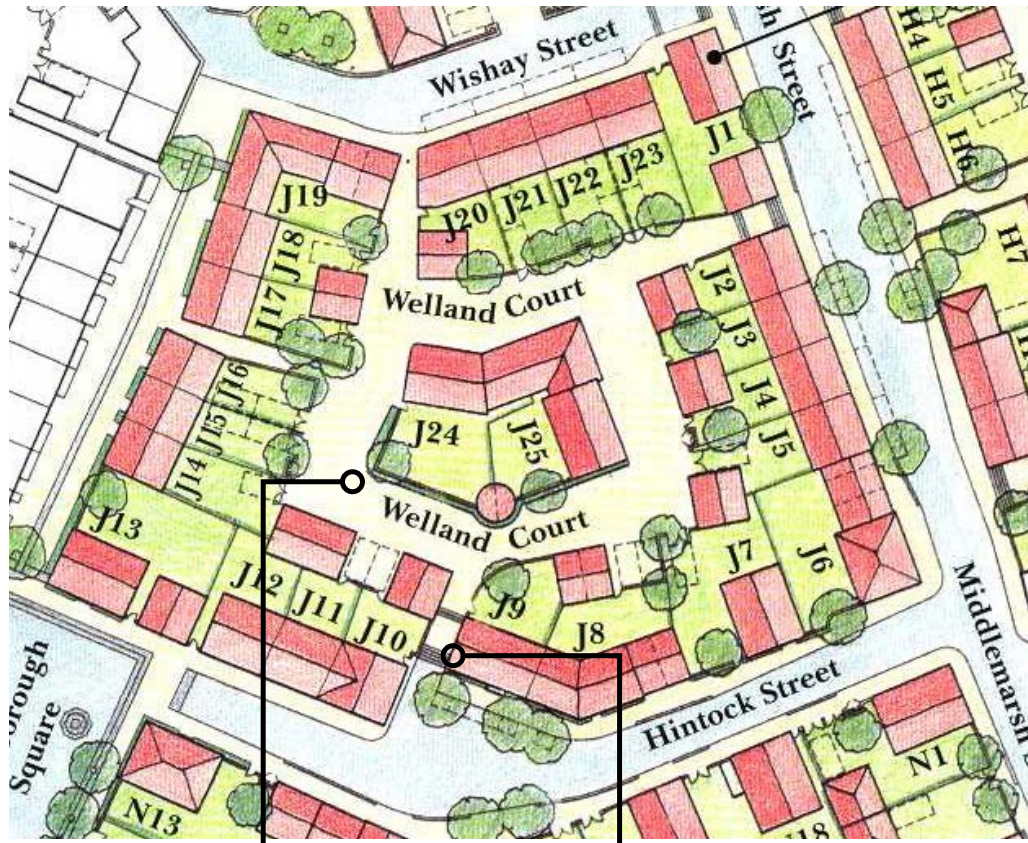

Example of shared surface with integrated parking



Example of typical court access

There are some key design principles that should be taken into account when considering a shared surface scheme. **These principles are important in the implementation of successful schemes such that if not incorporated, it may be inappropriate for the scheme to be considered.**

In terms of the principles, shared surface streets should:

- ◊ *have a design speed close to walking/cycling speed, ie less than 10mph;*
- ◊ *feature controls on parking, permitted parking only in designated and well defined areas and limiting parking so that it does not dominate the street;*
- ◊ *feature measures to encourage social activity within the street, such as benches, play areas and street furniture;*
- ◊ *be clearly a different environment from a traditional street, by means of surfacing, signing and the presence of planting green space, trees or street furniture;*
- ◊ *be designed wherever possible with community involvement, to ensure the buy-in of the main end users of the scheme;*
- ◊ *take full cognisance of the needs of disabled people and vulnerable road users, in appropriate locations, providing safe space to protect users and assist with navigation through the area; and*
- ◊ *provide considered access to underground services, drainage and location of street lighting systems such that comply with regulation and best practice.*

(d) **Integrated Parking** (Page 40 of [Designing Streets](#))

Parking and Servicing requires recognition of the development's function balanced against reducing the visual dominance of parked vehicles. Internal accommodation or possibly year round landscaping to parking areas needs consideration.

In addition, the evolution of car design has resulted in increased car sizes over recent years, rendering much of the previous car parking spaces guidance outdated and no longer fit for purpose. Refer to Parking Standards in Part 3.

To better accommodate vehicle parking whilst balancing the impact on a place, garage parking allowance should be considered providing the garage dimensions permit the effective use of that building for that purpose. Key requirements for a garage space is that a car can easily access the garage and the driver can egress the car comfortably thereby encouraging the garage's use for that purpose. Consideration to the in-curtilage parking and positioning of a building within a plot together with storage and cycle parking should be given to reduce visual impact. Refer to Parking Standards in Part 3.

For flatted or other types of developments, underground or internal undercroft parking is a good solution and is practical for developments of a size where access ramps can be accommodated or topography easily permits its use. Effective design of internal parking permits buildings to be located forward on the building plot thereby removing the traditional parking area at the front of buildings and maximising private space to the rear of the building.

Research by Transport Research Laboratory (TRL 661 [🔗](#)) has shown that the presence of on-street parking can reduce vehicle speeds. However, there remains concern that crossing the road between parked cars remains a safety issue, particularly for young children. Additional design challenges need to be met where the road constitutes an arterial road and where the surrounding function is more than residential only. Car free developments are not considered appropriate, as residents will park in surrounding streets, thereby limiting effectiveness. Parking should be allocated on an estate-wide basis



Provision for bicycle parking requires particular attention when considering the form of a new development. Reference to [Cycling by Design](#) and [LTN 2/08 Cycle Infrastructure Design](#) is recommended for all new road layouts. Larger developments with significant infrastructure may warrant off-street or parallel-to-street dedicated facilities. The guidance above relating to the designer making the road up from user defined lanes can assist in this provision. In encouraging cycling it is important that safe, secure and convenient places are provided within developments for the storage of cycles. Inconvenient or difficult to access facilities should be avoided.

(e) Emergency and Service Vehicles

Types of traffic using a road do require adequate facilities to ensure a safe environment; HGV and bus traffic lanes by necessity are wider than car only lanes. The sharing of road space for cyclists requires additional space as does on-street parking. In essence, the lane width and therefore road width is built up within the design based on User Requirements. This should not be interpreted as merely all residential streets must always cater for HGV waste management and winter maintenance vehicles as clearly their use is minimal. Reference for Emergency and Service vehicle provision is detailed in [Designing Streets](#). Further guidance on this is detailed later: refer to 3.1.5.

2.2.7 Street Detail

(a) Drainage and Sustainable Urban Drainage Systems (SUDS)

Water quality and the need to consider controlling rainwater runoff rates and its infrastructure are two key factors that have driven the need to identify more sustainable drainage solutions for all forms of new development. There is now a legislative requirement, through the introduction of [The Water Environment \(Controlled Activities\) \(Scotland\) Regulations 2011](#), commonly referred to as CAR, that to comply with General Binding Rule (GBR) 10, surface water runoff from areas constructed after 1 April 2007 must be drained by **Sustainable Urban Drainage Systems (SUDS)** so that all reasonable steps are taken to ensure the discharge will not result in the pollution of the receiving water environment.

The design of an integrated sustainable urban drainage system needs to be considered by the developer at an early stage to ensure the benefits of such a system are fully realised within the proposed development.

Design guidance can be obtained from [The SUDS Manual, CIRIA no C753](#) and from [SUDS for Roads](#). Additional local guidance for developers may also apply.

Developers are recommended to consider a SUDS system in terms of a master planned approach as a sectionalised or phased approach is unlikely to gain approval.

A key requirement is that the in-perpetuity maintenance and management of any Road SUDS system is clearly attributed to a regulatory body such as Scottish Water or the Local Authority

and that this agreement together with boundaries of responsibility is clearly indicated on plans submitted for RCC.

The design of new residential developments should apply the following principles:

- *SUDS must be an integral component of the design from its inception, with the connections into the wider network identified.*
- *All parts of a shared surface water system for road and curtilage water must be designed to allow future adoption/vesting by an in perpetuity regulatory body. This will normally mean that on any specific site, Scottish Water and/or the local authorities entering into an agreement to confirm adoptable standards together with future maintenance boundaries at the outset and that agreement forms a material part of the RCC application. Refer to the SUDS Schedule on page 172.*
- *SUDS should be developed in conjunction with the roads layout and landscape strategy, have regard to any sensitive environmental receptors and be integrated with the wider wetland habitat networks.*



Initial investigations on drainage and SUDS need to establish the soil and hydrological conditions of the area and the site. This information directs the design principles for the development and are submitted as part of the RCC application process including future regime for maintenance, discharge location and methodology of calculating surface water discharge rates.

The levels of treatment listed below represent best practice. Please be advised that for mixed use developments, the level of treatment required will be determined by the use with the highest sensitivity within the development.

- *All roads schemes typically require two levels of treatment, except for residential developments of 50 houses or less and retail/commercial/business parks with car parks of 50 spaces or less. For technical guidance on SUDS techniques and treatment for roads please refer to the **SUDS for Roads** [manual](#).*

More detailed information:

- *Residential developments of 50 houses or less and retail/commercial/business parks with car parks of 50 spaces or less require one level of treatment for all hard standing areas including roads.*
- *Residential developments of more than 50 houses and retail/commercial/business parks with car parks of more than 50 spaces require two levels of treatment for all hard standing areas including roads. An exception is run-off from roofs which requires only one level of treatment. Recommend best practice, the second level of treatment to be a basin or pond designed in accordance with **Sewers for Scotland Third Edition** [link](#).*
- *Industrial developments require three levels of treatment for hard standing areas and two levels of treatment for roads. An exception is run-off from roofs which requires only one level of treatment. Recommend best practice - the second level of treatment to be a basin or pond designed in accordance with **Sewers for Scotland Third Edition** [link](#).*

Developers should also note the following:

- *The appropriate levels of SUDS treatment should be provided in new developments. Further advice regarding the surface water treatment, and levels of treatment, is available from the following **SEPA link** [link](#).*
- *Any in-curtilage SUDS (private) **must** have a strategy and evidence for long-term maintenance.*
- **Whole Life Costs (WLC model)** [link](#) *and future maintenance issues will be key to the successful selection of any given SUDS design. Surface water discharge from SUDS does not require a licence under the WEWS CAR regulations unless they are draining:*
 - ▣ *>1,000 residential houses;*
 - ▣ *>1,000 car parking spaces;*

- ▣ industrial areas;
- ▣ major road/motorway;

in which case a simple license is required. This applies to surface water discharges arising from the above activities which are new or enlarged. It does not apply to existing surface water discharges, unless SEPA considers that additional controls in the form of a licence are required.

In the case where soil saturation levels have been reached, flood paths are required to be identified such that roads are kept free of ponding water and that housing or buildings are not put at risk.

(b) Flood Risk Management

A key requirement for any development is flood management and determining any potential flood risks. All developments should be screened to determine if there are any potential flood risks from the following sources:

- ◇ fluvial (flooding from rivers and burns);
- ◇ pluvial (ponding of rainwater which has not entered any drainage network, normally occurring in low lying areas);
- ◇ sewer;
- ◇ overland flow/flood routing;
- ◇ ground water;
- ◇ coastal flooding.



If any of the aforementioned flooding sources are identified there will be a requirement to carry out a **Flood Risk Assessment**.

The Local Authority's Flood Management team should be consulted at the conceptual stage of all development to discuss these requirements.

(c) Utilities

All developments require utility servicing and this should be planned at the outset so as not to conflict with other road aspects and as a rule are placed within the road boundary. The use of ducting and utility combined ducts which result in minimum disturbance to the road surface for maintenance is encouraged. The provision of service strips requiring ground management requires clear demarcation from private ground. Where green service strips are proposed alongside shared space, these are intended to connect to adjacent garden grounds. These are unlikely to be supported where walls, fences or hedges are proposed separating these from such gardens

Where high-quality surfaces are proposed, ducting of utility apparatus is highly recommended to maintain the long-term integrity of such surfaces and reduce risk to such utility apparatus.

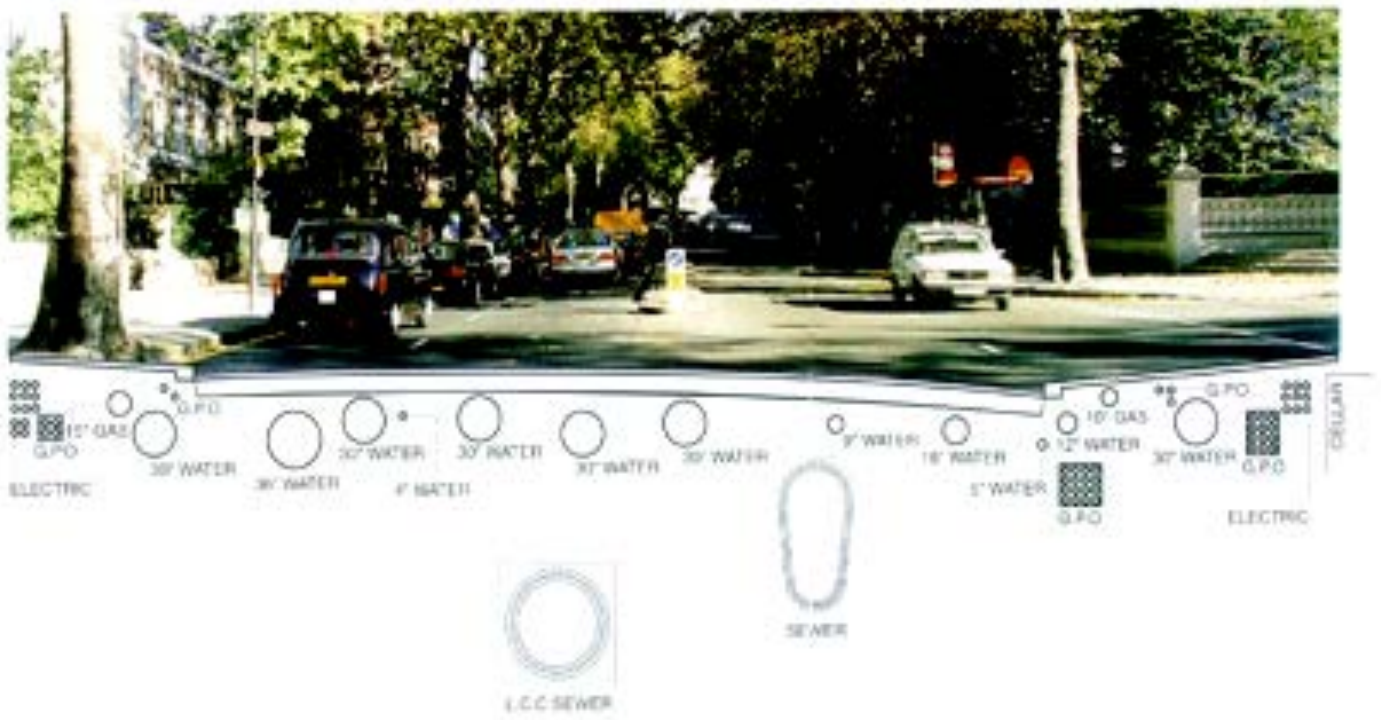



(d) Planting

Developers will require to arrange maintenance of planting or by an agreement with the Local Authority. Local Roads Authorities will not generally adopt planted areas except for grass verges within the road boundary, main road visibility splays and elements of the SUDS systems. Developers must detail management undertakings on proposed road adoption plans.



(e) Materials

Page 50 of [Designing Streets](#) outlines the principles of distinctiveness and durability to allow ease of maintenance. Section 2.4.10 in the adoption chapter that follows goes further in outlining the needs from the Roads Authority point of view.

(f) Reducing Clutter

Page 51 of [Designing Streets](#) outlines the principle to keep road or street marking and signage to a minimum. Locate furniture for maximum pedestrian benefit and light our streets discreetly.

2.2.8 Risk and Liability

Changes to road layouts and updated technical details as a result of [Designing Streets](#) (see page 60-63 of DS), SUDS and traffic management processes has caused some concerns for designers regarding litigation and liability. This is largely unfounded but to assist with these concerns reference should be made to UK Roads Liaison Group's [Highway Risk and Liability, Second Edition](#) for clarity based on stated case law.

2.2.9 Transport Assessments (Public Transport and Travel Plans plus Quality Audit)

Initial considerations should be to seek confirmation from Local Authority on whether a Transport Assessment (TA) or Transport Statement (TS) is required. There is no requirement to appoint a firm of Transport Engineers to undertake a TA but seeking advice from suitably qualified professionals would be recommended. The next stage is to submit a proposed scope for the TA for comment by the Local Authority and/or Transport Scotland (as necessary) and seek agreement to this before undertaking the assessment. If the scope is not agreed there may be a requirement to provide an addendum to the submitted document or a completely new submission.



Detailed advice on Transport Assessments can be found in the [Transport Assessment Guidance](#) and refer to section 3.2 in this Guide.

The Scottish Government guidance on Transport Assessments sets out requirements according to the scale of development being proposed; from a local development which requires a simple Transport Statement providing an explanation of transport issues through to a major development where detailed technical analyses will be required in a Transport Assessment accompanied by a supporting Travel Plan.

A Transport Assessment (TA) is required for most large developments where there is the potential for a major traffic impact on the surrounding transport network. These developments will typically include the following:

- *food and non food retail stores of over 1,000m² Gross Floor Area;*
- *hotels with more than 50 beds;*
- *residential developments with 100 dwellings or more.*

Transportation Statements which are a slimmed down version of a full TA are usually required in the following circumstances:

- *hotels with less than 50 beds;*
- *residential developments with between 50 and 99 dwellings.*

Please note however, that these are only guidelines and that a full TA can be asked for if the Council considers that the traffic impact of a proposed development merits such an investigation.

2.3 Adoption of Infrastructure

Adoption and Maintenance (Roads, SUDS, Landscaping (Public open space) etc)

2.3.1 Adoption of Roads

In Terms of Section 151 of the **Roads (Scotland) Act 1984** [↗](#), a road is defined as any way (other than a waterway) over which there is public right of passage etc (by whatever means) and includes the road's verge, and any bridge (whether permanent or temporary) over which, or tunnel through which, the road passes: and any reference to a road includes a part thereof. In terms of Section 16 of the **Roads (Scotland) Act 1984** [↗](#), the Local Roads Authority will, **upon request**, adopt, ie **add to its list of public roads**, any new road (including any associated footway or verge) constructed in accordance with a Construction Consent.



The Local Roads Authority will also include this road and associated footways, verges, drainage systems, green space, public areas and any other related infrastructure into its Roads Asset management Plan. However, clear demarcation of responsibilities must be identified and agreed by local authorities, Scottish Water and any other third party agencies party for the future maintenance of any element of the road and its drainage system, including open public space as a part of the RCC application.

Private Accesses

It is important to make the distinction between roads (recorded on the list of public roads or not) and private accesses. Roads have a public right of passage whereas private accesses are controlled by the owner(s) and there is no public right of passage. At the planning of a new road, its status as a Private access is identified and that it is not the intention of either the Developer or the road authority to ever have the road added to the list of Public Roads.

The suitability of a private road can be judged against some or all of the following criteria:

- ◊ *the road serves less than the adoption standards (2.1.4);*
- ◊ *the development is enclosed with no right of passage;*
- ◊ *the development consists of dwellings that are never to be adopted as permanent dwellings. For example, holiday homes that limit occupation to no more than 11 calendar months of any year regardless of numbers.*

For a road that for any reason has not been added to 'the list of roads' it is necessary to identify a responsible person as Road Manager who is identified through the Road Authority on the Scottish Road Works Register as defined in terms of the **Transport (Scotland) Act 2005**  in perpetuity.

Phased adoption of a project:

To avoid long delays between construction and adoption of roads, developers are recommended to programme construction to enable the adoption of roads to be phased as sections of work are completed, subject to the following:

- (a) *Each phase should have a separate Construction Consent **and if applicable, a Road Bond for Residential Developments.***
- (b) *Carriageways, footways, verges, relevant elements of a SUDS systems and lighting will not be adopted separately.*
- (c) *In general only lengths of road between junctions will be adopted.*
- (d) *All roads submitted for adoption should form a continuous system with existing public roads.*

Note: *Roads Authorities may choose not to adopt a completed section of road which is being used by construction traffic to access further phases of the development.*

2.3.2 Adoption of Parking Areas

In both new development and redevelopment, the developer will normally be required to provide parking spaces in accordance with the parking standards detailed and agreed at a Local Roads Authority level. The suitability of such areas for adoption or maintenance by the Local Roads Authority will normally be judged against the following criteria:

- (a) *Parking areas should be constructed in accordance with a Construction Consent.*
- (b) *Parking areas contiguous with the carriageway will normally be adopted as public roads provided that their use by the general public is not restricted in any manner.*
- (c) *Off-road parking areas, which have been identified as meeting a general public parking need and have been constructed to appropriate standards may be taken over for maintenance purposes (as agreed in advance by the Local Authority guides).*
- (d) *Parking areas provided in lieu of garages or private driveways for the regular parking of residents' cars will not be taken over for maintenance purposes by the Local Roads Authority and must, therefore, be subject to private maintenance agreements. They will remain either the responsibility of the Local Housing Authority or of the proprietors or factors in the case of private housing.*
- (e) *Clear demarcation must be provided between the prospective public road and privately maintained parking areas.*

2.3.3 Housing Courts

Housing Courts consist of a combination of the above elements and may be considered for adoption by the Roads Authority. Housing courts should be constructed in accordance with a Construction Consent.

Housing Courts serving less than 20 dwellings may be considered unsuitable for adoption.

2.3.4 Service Areas

Service areas in industrial or commercial developments, which provide loading facilities for the premises, will not normally be considered for adoption even though these may take the form of paved areas contiguous with the carriageway. A clear delineation of the private area will be required.

2.3.5 Adoption of Road Lighting and Electronically Controlled Signals etc

Lighting installations or electronically controlled signals on publicly maintainable roads, footpaths and parking areas may be taken over by the Roads Authority for operation and maintenance prior to the completion of the road works, provided that the following requirements are met:

- (a) *The submission of a separate acceptable **Completion and Inspection Certificate** for any lighting installation or part thereof that requires to be adopted during the construction period.*

- (b) *Acceptance by the developer of responsibility for any necessary repairs or replacements, arising from faulty workmanship or from the failure of materials, during the twelve months following adoption of the road as detailed in the RCC.*
- (c) *Written assurance from the developer that all roads concerned will be offered for future adoption in a timescale commensurate with the lighting adoption maintenance period.*
- (d) *Final acceptance will be withheld until all columns and control pillars etc have been numbered and, if required, painted.*

The road will not be adopted until the road lighting and control is completed.

2.3.6 Adoption of Cycle Tracks

A cycle track is a road for use by pedal cycles only or by pedal cycles and foot only. The adoption of cycle tracks will therefore follow the procedures for the adoption of roads. The suitability of cycle tracks for adoption will be judged against the following criteria:

- (a) *Cycle tracks should be constructed in accordance with a Construction Consent.*
- (b) *Cycle tracks must form part of a general cycling network interconnecting houses, shops, schools, public transport, etc and be available to cyclists and pedestrians on an unrestricted basis.*
- (c) *At least one end of the cycle track should be connected to a public road carriageway to facilitate access for maintenance purposes.*

Where a cycle track is constructed by the developer on land primarily intended for recreational or similar purposes to be managed by Council's Services, the cycle track will not require to be adopted but a Construction Consent may be required; Road (Scotland) Act 1984 Section 151(3). If built by a Developer it needs technical approval.

2.3.7 Adoption of Cycle Parking, Bus Shelters, etc

The provision of bus shelters, cycle parking and other facilities may be constructed as part of a development to satisfy the requirements of the Council.

These will normally be adopted subject to the following criteria:

- (1) *They should be constructed in accordance with the Council's requirements.*
- (2) *They should form part of a general network connecting centres of activity or other sections of public road and be available to users on an unrestricted basis.*

2.3.8 Adoption of Sustainable Urban Drainage Systems (SUDS) for Roads

In terms of this guide where any part of a road is drained into SUDS that system is subject to a Construction Consent.

As a fundamental element of that Consent, a clear demarcation in the form of a **schedule of agreement** (refer to section 3.9) together with plans indicating the prospectively adoptable elements by the Road Authority and Scottish Water which identifies the detailed SUDS adoption agreements in advance of each specific development will be required as part of the Construction Consent process.

The element of SUDS that is apportioned to the Road Authority will be adopted providing:

- (a) *all elements of the SUDS for roads should be constructed in accordance with a Construction Consent;*
- (b) *written evidence that the proportion of SUDS to be vested by Scottish Water is to be constructed to their standard.*



2.3.9 Pipes and Culverts Under Roads

For pipes and culverts under roads a hydrological study of the catchment area along with a hydraulic design of the proposed pipe or culvert and outfall should be provided along with confirmation that this has been checked independently. Grilles should be designed to facilitate ease of maintenance and prevent flooding and, where possible, grilles should allow for overflow during flood conditions or where the grille face is blocked with debris: refer to section 3.9.

(a) Drainage Outfall to Watercourse

Where connection of the road drainage to a public sewer is not possible alternative arrangements for road drainage should be agreed with the Roads Authority, Water Authority and **Scottish Environmental Protection Agency (SEPA)** [🔗](#).



2.3.10 Structures Agreements

Where a Construction Consent provides for a road to be supported by a bridge, the Roads Authority will normally enter into an agreement with the developer, in terms of Section 79(1)(c) of the [Roads \(Scotland\) Act 1984](#), whereby the bridge will heritably vest in the Local Roads Authority. Other essential structures such as retaining walls will also require an agreement to enable these structures and solums to vest in the Local Roads Authority. However, where the bridge or other structure and solum has not been so acquired, the Local Roads Authority will be responsible only for maintaining the road surface.

2.3.11 Roads Bonds

In terms of Section 17 of the [Roads \(Scotland\) Act 1984](#) and the *Security for Private Road Works (Scotland) Regulations 1985 Amended 1998 (SI 2080)* developers are required to make financial provision with the Local Roads Authority in order to safeguard the completion of roads detailed under the Act and which are the subject of a Construction Consent. Refer to [SCOTS RCC and Bond Guidance](#).

To clarify this issue, everything that conventionally constituted a road will be included in that valuation and includes carriageway, footways, cycle tracks, remote footpaths, verge, service strips, lighting, drainage and any other works normally associated with the road works.

The valuation of the Road Bond is set by the Local Authority based on costs for them to have the works completed up to the standard of the Construction Consent and is not subject to negotiation by the Developer.

Such provision may take the form of a Road Bond or deposit and protects prospective house purchasers from having to bring incomplete roads up to adoptable standards. **It should be noted that no building works can commence until such securities have been lodged and Developers must give “at least four weeks” prior written notice of intention to commence such works to the Local Roads Authority.**

A security in favour of the Roads Authority will also require to be lodged in cases where substantial works for commercial developments affecting the existing road network are being undertaken by private bodies eg roundabout, underpass etc (this by means of a Section 75 Agreement or Planning Obligation made under the [Town and Country Planning \(Scotland\) Act 1997](#) as amended by the [Planning etc \(Scotland\) Act 2006](#)). The Regulations concerning Road Bonds do not, however, cover private accesses.

Evidence of a sewer bond may be required from a developer prior to works commencing as part of the RCC process.

2.3.12 Delineation Public/Private

Delineation will be required between all private areas and the public road. This should be achieved by means of flush kerbs or other agreed form of delineation at the boundary and may incorporate gateways and/or change of surfacing.

2.3.13 Dilapidation Surveys

In a case where construction traffic from a major development exceeds previously experienced volumes on the adjacent public roads serving the site and this results in an increased rate of deterioration in those roads, the developer may be asked to enter into an agreement with the Local Road Authority in terms of Section 96 of the [Roads \(Scotland\) Act 1984](#). This agreement allows the Council to recover extraordinary expenses in repairing roads damaged by heavy vehicles or other extraordinary, vehicles or traffic, as a direct result of a development.

2.3.14 Quality Audit Including Safety Audit

Quality Audit should be incorporated into the overall street design submission, advice. Reference to Quality Audit - section 3.3.

A consistent approach to QA using DS should to be encouraged. A method that forms part of a toolbox aimed to gain wider, more consistent implementation of [Designing Streets](#) is described in section 3.3, Quality Audit Summary Report.

2.4 Applying for Construction Consent

2.4.1 Responsibility for Design

It is important to recognise that the granting of Construction Consent does not imply that the Local Roads Authority accepts any responsibility for the accuracy and suitability of any elements of the design. The responsibility of the Designer under the CDM Regulations 2007 shall remain with the applicants design consultant or agent.

2.4.2 Application Content Details

An application for Construction Consent should be made on Form CC1. Completed application forms should be submitted **at least three months prior to the commencement of construction** to the Local Roads Authority. Layouts which clearly do not conform to the Guidelines may have the drawings and documents returned for a new application to be submitted.

It is important to note that an application for Construction Consent will only be accepted once the submitted documentation is of a sufficient standard that it is judged by the Local Authority to describe all the construction details sufficiently that permits construction to progress without further information. Confirmation that a construction consent is acceptable and is being progressed should be confirmed by the Local Authority in writing.

(a) Submission of Plans

Applications for Construction Consent should be accompanied by one electronic and three paper copies of each of the following (initially only one paper copy is required for a preliminary check of the proposals):

- (a) **A location plan**, preferably on the Ordnance Survey base, to a scale of 1:1250 or 1:2500, showing the proposed road network and its relationship to existing development and road network.
- (b) **A layout plan** of the carriageways, footways, drainage system, verges, footpaths, retaining walls, cycle tracks, bridges and earthworks to a scale of 1:500 (1:200 where pedestrian/vehicle shared surfaces are proposed) showing:
 - (i) the proposed centre, building and kerb lines (and also the heel of the footway where this differ from the building line);
 - (ii) curve radii of the road alignment and junctions;
 - (iii) traffic calming measures where appropriate;
 - (iv) dimensioned visibility splays at road junctions and private accesses;
 - (v) forward visibility distances at bends;
 - (vi) vehicular access points to properties;

- (vii) *pedestrian crossing points at junctions and other locations;*
 - (viii) *the location of all road gullies, (if applicable);*
 - (ix) *the location of all the road drainage system and SUDS components and its discharge points (applicants can obtain information on discharge points from Scottish Water);*
 - (x) *the location and type of lighting columns and lanterns, wall-mounted lighting units (if applicable), control pillars, underground cables and road crossing ducts;*
 - (xi) *the location of all underground services and ancillary apparatus;*
 - (xii) *the full extent of all cut and fill slopes;*
 - (xiii) *the boundaries of any areas which it is intended will subsequently be offered for adoption or maintenance;*
 - (xiv) *road signs and road markings etc;*
 - (xv) **future maintenance responsibility of road drainage system by (a) Local Authority, (b) Scottish Water, (c) the developer;**
 - (xvi) **future maintenance responsibility of roads, footways, remote footpaths, cycle tracks, service strips, verges, SUDS, green space and public areas;**
 - (xvii) *fences and wall heights*
 - (xviii) *swept path analysis.*
- (c) **A longitudinal section** along the carriageway, footpaths and cycle tracks giving vertical alignment details, road drainage gradients with manhole positions marked thereon, together with the nature of the substrata to a depth of 1 metre below road formation level or to rock head where bedrock is at a depth less than 1 metre.
- (d) **Typical cross sections** through the carriageways, footways, footpaths, verges, cycle tracks and adoptable parking areas detailing widths, crossfalls, construction depths and materials used, kerb and edge details and typical details of gullies, gully connections, filter trenches, swales, detention basins and underground storage.
- (e) **A Quality Audit** should also be included following the template in section 3.3 of this guide. Where appropriate it should **include a range of audit or reports as identified, including a safety audit** for the design.
- (f) **A Factual Ground Investigation Report** and corresponding **Interpretative Report** making specific recommendations on the design of the proposed road.

The details submitted for construction and the specification for materials therein must comply with these guidelines. This may be indicated by quoting the relevant clause number of the specification, but it will not be sufficient merely to state that construction is to the agreed specification.

(b) Design of Structures

Where the submission includes proposals for road structures (eg culverts, retaining walls or bridges) the application will be subject to Technical Approval Procedures as outlined in BD2 of the Design Manual for Roads & Bridges.

(c) Docqueting of Plans

It is essential that the plans, detailed drawings and specification submitted with the application are docqueted. *“This is the an/drawing/specification referred to in the application”*, and personally signed and dated by the applicant or agent.

(d) Notification of Owners

Where any person other than the developer owns land which fronts, abuts or is comprehended in **the new road(s) or the extension of the existing road(s)** for which Construction Consent is being sought, the developer will be required to declare on Form CC2 that all such persons have been notified of the application for Construction Consent by the issuing of Form CC3, Notice for Service on Owner.

(e) Owner's Objections

Any person to whom the application has been intimated under the provisions of the preceding paragraph may, within twenty-eight days of the date of intimation, make written representation to the Local Roads Authority. Any such representations will be considered before Construction Consent is determined.

(f) Hearing of Applicant

Should it be considered that the application for Construction Consent should be refused or granted subject to special conditions, the applicant may within twenty-eight days of the date of intimation of such a decision appeal to Scottish Ministers.

2.4.3 Construction Period

It will be a standard condition of any Construction Consent that the construction be completed within the period specified in the Consent. This period will not be less than three years. If, as a result of a change in circumstances during construction, it is demonstrated that the specified period is no longer realistic, the Local Roads Authority may grant an extension subject to any conditions they consider necessary. In certain circumstances where requested by the Local Roads Authority a new application for Construction Consent must be made as well as a re-evaluation of the bond.

2.4.4 Amendments to Consent

Should the developer, for any reason, wish to depart significantly from the construction specification or layout details for which Construction Consent has been granted, he must submit a new application for Construction Consent. The new application will be subject to a revised Road Bond valuation.

Major changes may also require the submission of a revised Planning Permission. Under such circumstances, the local planning authority should be consulted for further advice.

Construction Consent approvals may be transferred from one applicant to another at the discretion of the Local Roads Authority, but may under certain circumstance result in a resubmission.

2.4.5 Recycled Materials

In accordance with Environmental Policies, local authorities actively encourage the use of recycled or alternative materials in road construction to minimise the environmental impact of the extraction of aggregates.

Recycled materials should be from a licenced recycling station which has demonstrated to the satisfaction of the Local Roads Authority its ability to produce recycled materials to the required performance standards.

Where Council specification are not available for the use of a particular material, proposals shall be submitted to the Local Roads Authority along with test certificates and details of source of supply for consideration. Refer to [MCDHW - Series 600](#), [700](#) or [800](#); also [WRAP Resource Efficiency in Highways](#).

2.4.6 Road Lighting and Signing

The developer will be responsible for the provision of all road, footpath and cycle track lighting, signing (whether illuminated or not) and alterations to existing lighting deemed necessary under Construction Consent.

2.4.7 Private Signs

It should be noted that it is illegal to erect private signs on street furniture or within the road boundary; for example, signs directing the public to developments. Approved signs, to the recognised standard, can be erected with the prior approval of the Local Roads Authority.

2.4.8 Road Bond

Where a developer is required to lodge a Road Bond or deposit, it should be submitted to the Road Authority at least 14 days prior to any house building commencing. Refer to 2.3.11 and [SCOTS RCC and Bond Guidance](#).

2.4.9 Construction Consent Forms

All the relevant Construction Consent forms, as detailed opposite, are included in the Appendices for the use of the applicant. Permission is hereby granted for these forms to be photocopied.

Form	Title
CC1	<i>Application for Construction Consent to Construct or Extend a Road</i>
CC2	<i>Notification of Adjacent Properties (Docquets of Service)</i>
CC3	<i>Notice of Service</i>
CC6	<i>Application for Addition of Roads (including footways/cycle tracks) to List of Public Roads</i>
CC8	<i>Carriageway Design Certificate</i>
CC9	<i>Construction Consent Checklist</i>

2.4.10 Non-Standard Materials

Where the developer proposes or is required to use, in the opinion of the Local Roads Authority, non-standard materials the developer should maintain a stock of 5% of non-standard materials at all times for the design life of the road. Alternatively the developer should deposit a stock of 5% of these materials with the Local Roads Authority within 3 years of completion of the contract subject to the availability of depot space

2.4.11 Failure to Comply

It should be remembered by developers that failure to comply with the procedures given in this document may result in refusal of Construction Consent. Developers are therefore encouraged to liaise with the relevant Authority at all stages of a scheme.

2.4.12 Inspection Procedures During Construction

(a) Notice of Commencement

- (1) **Four weeks' notice** must be given to the Local Roads Authority of the start of roadworks together with names and telephone numbers of responsible persons who may be contacted in connection with the construction of the works.
- (2) **Inspection and Testing**
During the construction period, irrespective of whether or not it is intended that the road(s) be subsequently adopted as public, the Local Roads Authority representative must be afforded access to the site to ensure that the works are being undertaken in conformity with the Construction Consent. The developer and/or his contractor should provide every facility to enable the Local Roads Authority representative to examine the works being executed and the materials being used, but will remain responsible for ensuring that standards are met.

(3) Notice of Operations

The developer or his contractor must give the Local Roads Authority representative a minimum 48 hours' notice (excluding weekends and public holidays) of:

- (a) completion of formation;*
- (b) commencement of each pavement layer to the carriageways, cycle tracks, footways and footpaths;*
- (c) each concrete pour (including blinding) and commencement of steelfixing where reinforced concrete is used;*
- (d) striking of formwork;*
- (e) setting out of road lighting plant positions, backfilling of cable trenches and painting of lighting columns;*
- (f) placing and testing of drainage systems.*

It should be noted that these are minimum requirements and that, in certain cases, the developer may be required to notify the Local Roads Authority's representative of additional construction stages.

Developers should also note that failure to notify the representative as above can result in covered over work to be exposed for inspection at the developer's expense to ensure that the construction complies with the Construction Consent.

Finally, failure to notify can result in delays to adoption or potentially seriously compromise the adoption process.

(4) Charges for Inspection and Testing

The Local Roads Authority reserves the right to charge for expenses incurred in inspecting, including any resultant undertakings, along with testing arising from the granting of Construction Consent. Samples of the various materials proposed to be used should be supplied, free of cost to the Local Roads Authority, together with particulars as to the source of supply or manufacture of such materials; or, at the discretion of the Local Roads Authority, test certificates may be submitted indicating the suitability of the materials proposed for use.

(b) Maintenance Period Inspection

On completion of a development road constructed in accordance with a Construction Consent, a request should be made to the Local Roads Authority to have a inspection carried out. As a result of this inspection, a list of any remedial work required to bring the road(s) up to the Local Roads Authority's standards will be prepared. Following the satisfactory completion of any such remedial work and the required maintenance period, an application may be made for the addition of the road(s) to the Local Roads Authority's list of public roads.

2.4.13 Applying for Adoption of Development Roads

(a) Application for Adoption

Following completion of a development road constructed in accordance with a Construction Consent, an application (using Form CC6 for its inclusion in the Local Roads Authority's list of public roads) may be submitted to the Local Roads Authority by the person to whom such consent was granted.

It should be noted that where at the planning stage it is the clear intention of the developer to have the road added to the list of Roads on completion, some Local Authorities may streamline this process by wording the Construction Consent's application forms in such a manner that this is agreed at that stage which precludes completion of this form at the later stages.

(b) Documents to Accompany Application

Prior to the Construction Consent being entered into its Maintenance Period, submission in the form of two copies of the plans, one paper set and an electronic set, containing all relevant as-built details, must be made to the Local Authority. The roads offered for adoption should be shown in colour, and the plans should clearly indicate the ownership of all areas so coloured. The application for adoption should include the Safety File as required under the Construction (Design and Management) Regulations 2007.

(c) Road Lighting

Similar to above the submission should include two copies of a signed Lighting Completion and Inspection Certificate CC10 together with as installed plans which must show the positions and circuit arrangements of all lighting apparatus.

(d) Road Drainage

The road drainage offered for adoption should be shown in colour and should clearly show future maintenance responsibility by:

- (a) the Local Authority;
- (b) Scottish Water.

The application for adoption should also include a CCTV survey of the road drainage to be adopted by the Local Authority.

(e) Adoption Inspection

Within a period of twelve months from the time of application for adoption of a development road, an inspection will be undertaken by the Local Roads Authority to ensure that the road has not deteriorated to a standard below that required for adoption.

2.4.14 Addition to List of Public Roads

Following a satisfactory adoption inspection, the road(s) shall be added to the list of public roads, in terms of Sections 16 and 18 of the [Roads \(Scotland\) Act 1984](#) , as appropriate.

2.4.15 Release of Road Bond

The Local Roads Authority may on request of the Developer release an appropriate amount of the Road Bond in respect of a section of road within a Construction Consent where:

Stage 1 - *In accordance with the Road Construction Consent and the road being constructed up to Binder Course, Surfacing Course where modular blocks are specified, the Sustainable Urban Drainage System or other drainage system is complete and functioning, all underground infrastructure is fully installed and standards of work agreed with the adopting authority and any appropriate kerb log is completed.*

Stage 2 - *Completion of all other items as detailed on the Construction Consent up to substantial completion which should only omit such items as grass or soft landscaping elements due to annual planting periods.*

Stage 3 - *Expiry of the Maintenance period (or the expiry of maintenance period of defects required identified during that period) or the addition of the private road concerned to the local Authorities List of Public Roads, whichever is the earlier.*

The Local Roads Authority will retain **a minimum** of 10% of the original security lodged until such time as the road has completed satisfactorily its maintenance period or been added to the list of Public Roads, whichever is earlier.

Part 3

ROADS DEVELOPMENT GUIDE



Click map to see regional variations



DETAILS

Part 3 - Details

3.1 Road Design	72
3.1.1 Junctions	72
3.1.2 Private Access	74
3.1.3 Design Details	76
3.1.4 Pedestrians and Cyclists	87
3.1.5 Servicing	97
3.1.6 Statutory Undertaker Services	100
3.1.7 Rural Areas	104
3.1.8 Street Planting Considerations	108
3.1.9 Additional Considerations	110
3.2 Transport Assessment	111
3.3 Quality Audit	113
3.4 Construction Design	117
3.4.1 Geotechnical Considerations	117
3.4.2 Specifications	119
3.4.3 Subgrade Drainage	119
3.4.4 Carriageway Construction	120
3.4.5 Street Transitions Methods	123
3.4.6 Footway, Footpath and Cycle Track Construction	125
3.4.7 Kerbs and Edging	125
3.4.8 Accesses	126
3.4.9 Road Drainage and SUDS	128
3.4.10 Landscape Treatment	133
3.4.11 Lighting Design	136

3.5	Parking Considerations	139
3.5.1	The Application of Parking Standards	139
3.5.2	Environmental Considerations	139
3.5.3	What is a Parking Space?	140
3.5.4	Parking Standards in Urban Areas	140
3.5.5	Shared Use Provision	140
3.5.6	Extensions and Change of Use	140
3.5.7	Commercial Vehicles	140
3.5.8	Coaches	141
3.5.9	Provision for Cycle Parking	141
3.5.10	Provision for Powered Two-Wheeler Parking	142
3.5.11	Provision for Disabled Parking	142
3.5.12	Planning Obligations	143
3.6	Parking Design and Layout	143
3.6.1	Pedestrians	144
3.6.2	Vehicles	144
3.6.3	Disabled Parking Design	146
3.6.4	Residential Parking Design	147
3.6.5	Powered Two-Wheeler Parking Design	156
3.6.6	Cycle Parking Design	157
3.7	Parking Standards for Use Classes	158
3.8	Structures Technical Approval	173
3.9	SUDS Schedule	173

3 Details

3.1 Road Design

3.1.1 Junctions

The range of junction types and arrangements are discussed in [Designing Streets](#) (page 36). This section details required junction criteria to enable a design to function correctly in relation to its user demands.

The functionality of a junction design should be demonstrated by swept path (or tracking) analysis based on the defined user needs appropriate to that junction. The swept path defines the minimum road space required to serve that junction's needs but is not considered necessarily the required kerb boundary line. It merely demonstrates the junction's ability to accommodate the intended traffic use.

(a) Form of Junctions

Where any new development gains access to the existing road network, the detailed form of the junction will depend on various factors including user demand in the form of volume and type of traffic, the manoeuvres made by these vehicles, the potential delays and queues, provision for vulnerable road users etc.

(b) Location

It is preferable to site any junction on level ground or in sags rather than at, or near, the crests of hills. Where possible, T-junctions on curves should be sited so that the minor road is on the outside of the curve. Junctions on the inside of sharp curves are most undesirable.

(c) Visibility Splay Area

Stopping sight distances and visibility requirements are detailed in [Designing Streets](#) (pages 33-35).

(d) Visibility Splay at Bend

Where the side road joins the road at a bend the Y distance should be measured on the kerb line along the bend but the visibility splay will be determined in a straight line (see Figure 6).

(e) Effects of Gradients on Visibility

When a minor road forms an uphill approach to the major road care should be taken to ensure that objects within the visibility triangle although less than 1.05 metres above carriageway level do not interfere with visibility.

Figure 6 Visibility Splay

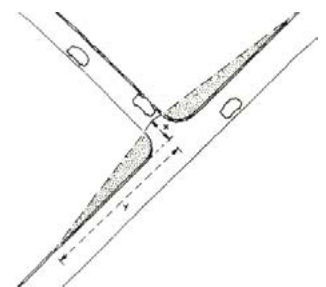

(f) Frontage Access and Parking at Visibility Splays

Obstructions to visibility are detailed in [Designing Streets](#) (page 35). Encroachment of parking spaces into visibility splays should be avoided where practical.

(g) Speed Control

Within residential areas low radii corners and/or narrow trafficked lanes can be incorporated which will assist speed reduction.

(h) Forward Visibility

Application

In residential developments, the reduction of drivers forward visibility heavily influences the reduction of vehicle speeds which is considered essential for the road network to function safely.

However, on main and strategic routes, forward visibility is considered where journey time is an economic factor.

Height of Visibility Envelope

Refer to page 33 of [Designing Streets](#).

Construction of Forward Visibility Splay

To ascertain whether the appropriate forward visibility will be achieved a line should be drawn along the vehicle path at a distance of 1.5 metres from the kerb to represent the driver's position (page 35 [Designing Streets](#)).

Visibility at Curves

Refer to [Designing Streets](#).

Reduced Forward Visibility

Forward visibility can be reduced below the constructed visibility splay process in [Designing Streets](#) page 35 by applying to the road authority and outlining the reasons justifying the reduction within the Quality Audit (see Figure 7).

Main and Strategic Roads or Steep Gradients

MfS2 suggests that Bus/HGV SSD should not be assessed except where it is in excess of 5% of traffic flow. Additionally, where steep road gradients are considered to be factors the basic formula for calculating SSD (in metres) is recommended: refer to section 2.2.5.

$$SSD = vt + v^2/2(d + 0.1a)$$

Where: v = speed (m/s)

t = driver perception - reaction time (seconds) (for HGV and bus traffic, use pre MfS1 value of 0.375g)

d = deceleration (m/s²)

a = longitudinal gradient (%) (+ for upgrades, - for downgrades)

Figure 7

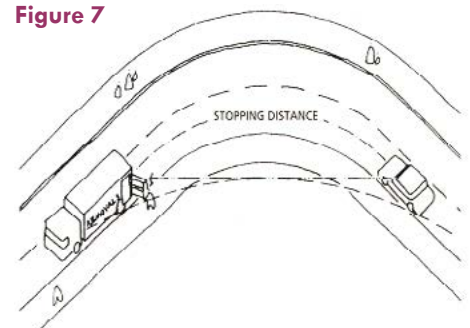

3.1.2 Private Access

(a) Access Criteria

Similar to the above criteria, private vehicular access to developments will require to accommodate the numbers and types of vehicles using the access in a safe manner. The form of access may also require to be enhanced in order to accommodate pedestrians and cyclists.

(b) Segregation at Commercial Accesses

In the case of commercial developments, vulnerable users should be provided with a separate pedestrian access.

(c) Individual Dwellings

In general, access to individual dwellings should be by means of a dropped kerb footway crossing as shown in Figure 8. In rural or semi-rural areas the x and y distance is dependent on the speed of traffic on the road based on the relevant speed limit applicable at that location.



Figure 8 Driveway Access

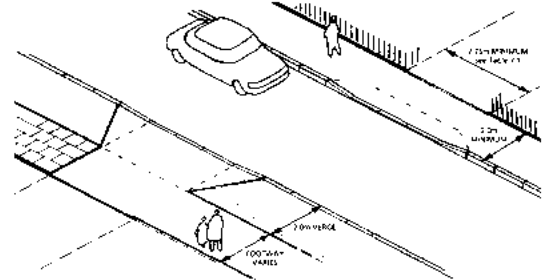

(d) Access Layouts

Access layouts are shown in Figures 9 to 11. Note: These details require to be updated to narrow ramps and consistent passage along footway.

Figure 9 Single Minor Commercial Access, Housing Court or Car Park up to 50 spaces

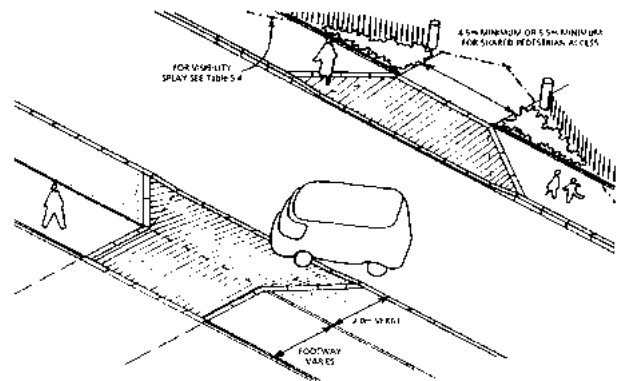

Figure 10 Minor Commercial Access or Car Park with more than 50 spaces

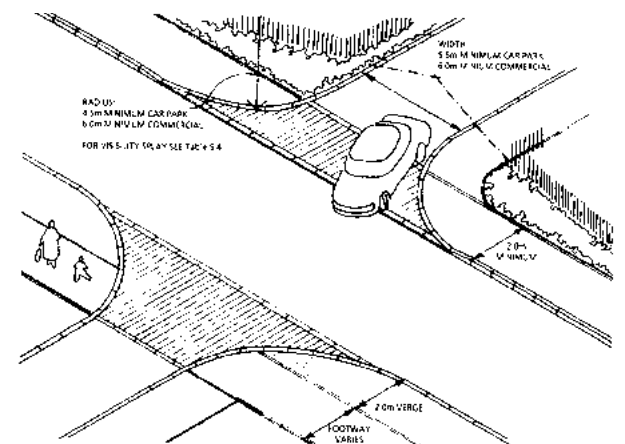
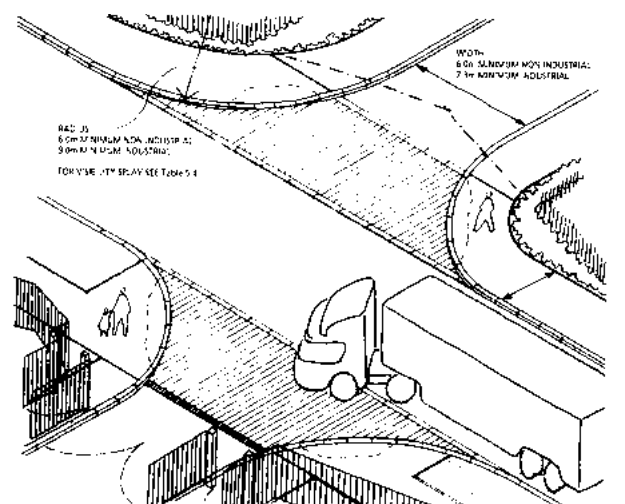

Figure 11 Major Commercial or Industrial Access



3.1.3 Design Details

(a) Minimum Traffic Lane Widths

Public Transport

Carriageways on bus routes should not generally be less than 6.0m wide, although this could be reduced on short sections with good inter-visibility between opposing flows.

Bus priority is most commonly achieved by providing with-flow bus lanes, and unless signed to the contrary they can be used by cyclists. Bus lanes should be 4.25m wide and the minimum preferred width is 4m; this allows buses to overtake cyclists safely and reduces the likelihood of interference from general traffic in the adjacent lane. The minimum recommended width is 3m.

Service Vehicles

Service vehicles by their very nature are infrequent users of the road and their incorporation into the design should not dominate the overall design.

The frequency with which they use each road should be considered and the road should be designed to match the need. High frequency use of HGV service vehicles will require that the road width is suitable to accommodate these vehicles traveling in both directions and the width should ensure that they can pass each other safely and at the appropriate speed. Where indicated by a swept path analysis, bends may also incorporate appropriate widening to ensure that they can travel along the road in a safe and appropriate manner.

Where their use is less in residential areas with a high place function and they are unlikely to meet each other traveling on opposite directions, the road width can be reduced accordingly. In these circumstances HGVs can use all parts of the road and cross the centreline. However, and road design in these situations must incorporate a swept path analysis to ensure that all HGV service vehicles can travel along the road without complicated manoeuvres being required.

Figure 12

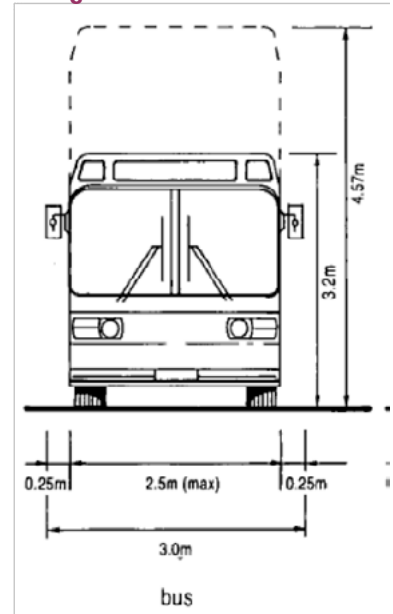
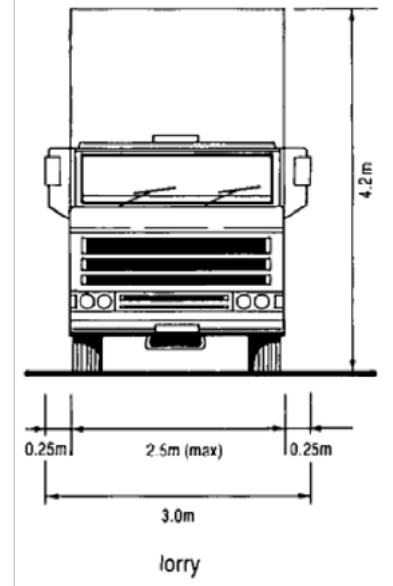

Figure 13



Design Considerations

UK practice has generally adopted a standard lane width of 3.65m but this should not be taken as a preferred value in all circumstances.

On strategic and arterial routes generally subject to national speed limits, this road width should be used and the layout should generally meet the standards in [DMRB](#).

The geometric design of a carriageway has generally been based on the notion of a design speed, which in the past has tended to be fixed along a route, or a substantial section of a route. The images on page 17 of this guide indicate that it is insufficient to consider that a road remains unchanged along its length and the balance between place and movement alters along its length. Therefore it is acceptable to vary road widths to suit circumstances.

The findings in TRL661 indicates that the context through which drivers pass does have an effect on their chosen speed and that speeds will be affected by road width and alignment and areas where conflict may be perceived by drivers.

Narrower lanes will be appropriate in many circumstances, particularly in built up areas, resulting in carriageways that are easier for pedestrians to cross and encouraging low traffic speeds without causing a significant loss of traffic capacity. The needs of cyclists will need to be expressly considered however, as discussed above.

Road design should therefore create an environment where drivers tend to slow down to an appropriate level in areas with a high place function which are generally urban areas, where road space is shared between motorised traffic, pedestrians, cyclists and public transport, and keeping speeds low has been demonstrated to have significant safety benefits.

The lane widths should be determined based on the following local consideration:

- ◊ *the volume and composition of vehicular traffic;*
- ◊ *pedestrian and cyclists' needs;*
- ◊ *the demarcation, if any, between carriageway and footway (eg kerb, street furniture or trees and planting);*
- ◊ *whether parking is to take place in the carriageway and, if so, its distribution, arrangement, the turnover of spaces, and the likely level of parking enforcement (if any);*
- ◊ *the design speed; and*
- ◊ *the curvature of the street (bends require greater width to accommodate the swept path of larger vehicles).*

Road design should therefore commence with an analysis of the types of road users anticipated on the route along with the design speed.

This should be considered along with the percentage of HGVs and buses and where this is expected to be high then widths should be able to accommodate these larger vehicles to pass each other in free flowing traffic.

The road width should be considered by the creation of lanes which allow the appropriate vehicles to travel along the road.

Typical vehicle widths are shown in figures 12 to 14 and summarised in the table below and these can be taken as a guide to minimum lane widths.

Figure 14

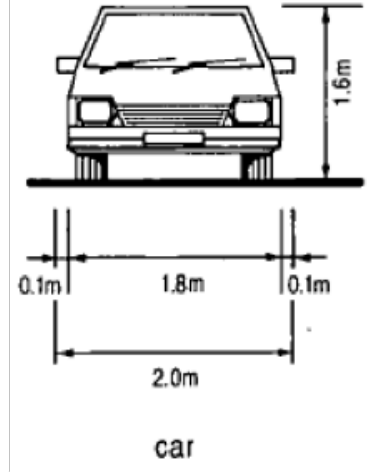

Vehicle	Width (m)	Total Width (m) (see figures)
Bicycle	0.6	1.0
Bus	2.5	3.0
HGV	2.5	3.0
Van	2.2	2.6
Car	1.8	2.0

The road width can then be defined by the clearance necessary to allow vehicles to travel at the appropriate speed. Clearances need to be specified between vehicles and between the vehicle and the kerbline as detailed in the table below.

	20 mph Design Speed	30 mph Design Speed
Kerb to vehicle clearance	200 mm	250 mm
Vehicle to vehicle clearance	300 mm	800 mm

Thus for example, where HGVs and buses make up only a small proportion of traffic flow, 2 m wide lanes would be sufficient for most vehicles. For a design speed of 20 mph the appropriate clearances would give a carriageway width of 4.7 m. Note: refer to minimum road widths. Conversely for a design speed of 30 mph with a large number of HGVs and buses then 3 m wide lanes with the appropriate clearances would give a carriageway width of 7.3 m.

Carriageway and lane widths do not have to be constant. Varying the width through non-parallel kerb lines or other physical limits can create interest, provide informal parking opportunities at widenings and traffic speed reduction at narrowings. The needs of cyclists at narrow points should be considered in detail.

These widened areas should be sympathetically designed to address the visual intrusion of unsympathetic road features such as traffic signs, road markings, street furniture and excessive carriageway width. These can be in conflict with local place functions. The opportunity for designers to employ 'natural' features should be considered, for example grass or grassy banks, appropriate trees and shrubs and also seating. Experience has shown that a more sensitive approach can bring sensitive benefits.

Where HGV and/or bus flows are low, it may not be necessary to design carriageways to cater for two large vehicles meeting at any point on the road. This will include refuse vehicles, delivery vehicles and removal vehicles. Tracked routes for these vehicles will need to prove that the road width is capable of allowing these vehicles to pass along the road in a forward gear without requiring to reverse at any point along the route.

Where HGV and/or bus flows are higher carriageway widening may be required for horizontal curves. This should be assessed using tracking software.

The use of overrun areas can be considered to accommodate larger vehicles and further guidance is given on their use in [Designing Streets](#) .

Drivers' perception of the appropriate driving speed is also influenced by the relationship between the width of the street and the height of vertical elements. It can be shown that speeds are lower where the height of vertical features is greater than the width of the street. Therefore care should be taken where the carriageway is widened that a vertical effect to narrow the visual width is created by the inclusion of trees or other vertical features.

One of the six qualities of design included in *Designing Streets* is 'adaptability' and the design of a road must consider any future development to ensure that property boundaries do not define the end of a road. Careful consideration needs to be given to road widths to allow future integration with other areas, particularly in the context of larger master planned residential areas.

Design Parameters

The design parameters to be utilised for each type of road within the road hierarchy are given in Table 3 on the following page.

Table 3 *General Road Geometry*

Maximum Gradient	
Strategic Road	6%
Industrial Road	5%
Primary Street	8%
Residential Street	8%
Shared Surface Road	8%
Minimum Gradient	
Strategic Road	0.8% (0.5% with special drainage provision)
Industrial Road	0.8%
Primary Street	0.8%
Residential Street	0.8%
Shared Surface Road	0.8%
Minimum Vertical Curve Length ($K \times$ algebraic difference in gradient)	
Strategic Road	Crests: $K=17$ (10 if traffic calmed) Sags: $K=13$ (9 if traffic calmed)
Industrial Road	$K=6$ (minimum length = 20m)
Primary Street	$K=6$ (minimum length = 20m)
Residential Street	$K=3$ (minimum length = 15m)
Shared Surface Road	$K=2$ (minimum length = 10m)

Notes:

- (1) Roads intended for use by buses are subject to a maximum gradient of 6.7%.
- (2) Roads constructed with modular surfacing are subject to a minimum gradient of 1.25% and a maximum of 7%.

(b) Housing Road Widths

Minimum Road Width

The development of a road layout must consider the user defined use in the quality audit. This approach permits variance on a road design however the functionality must be retained with minimal road widths. Where roads are narrow, consideration for placing street lighting such that it is set back from vehicular passage whilst being on adoptable land must be demonstrated in application plans.

Shared Surfaces

The above hold true for shared surfaces however provision for pedestrian passage and disabled users must be demonstrated in application plans as well as regard for locating and protecting street lighting columns.

Passing Place Configuration

A passing place should provide a minimum road width of 5.5 metres and the length is proportionate to the mean average vehicle type of the road users, reference to on street car parking bays sizes together and vehicle types will assist this design (see Figure 15).

Figure 15 Car and HGV Passing Places

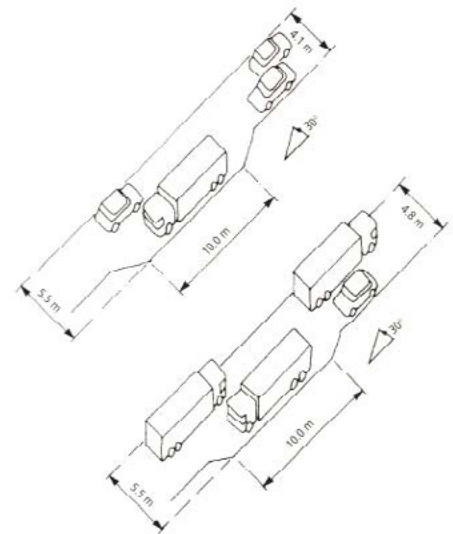
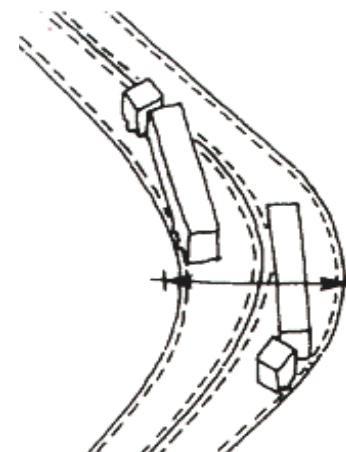

Figure 16 Car and HGV Passing Places



(c) Carriageway Widening on Curves

Swept path analysis will dictate minimum road width criteria at such locations. As a rule, vehicles should not cross the center line of a road which has a speed limit of 30mph or more or carries more than 500 vpd. On a swept path analysis, where a large vehicle is indicated as crossing the center line of the carriageway to negotiate a bend or junction, traffic volumes must be minimal with associated speeds less than 10 mph for the crossing vehicle (see Figure 16).

(d) Gradients and Crossfalls

Minimum Gradients

Channel gradients should not be flatter than 0.8% (1 in 125). A change from camber to crossfall should not coincide with a sag point in the longitudinal gradient or on a section of road where the gradient is less than 1% (1 in 100).

Crossfalls

Carriageways should be cambered with a fall of 2.5 per cent from the centerline to the channel except on curves where, to eliminate adverse camber, a crossfall between channels should be provided as per the place/movement link design tables in Part 1.

The carriageway cross fall may vary when applying other design criteria such as roundabouts and corners and is dependent on design speed and change of direction refer to [TD 16/07](#) and [TD 9/93](#).

Maximum Gradients

Steep gradients should be avoided as the associated footways can cause problems for those with a mobility handicap. Gradients in excess of those shown may be permitted in hilly terrain at the discretion of the Local Roads Authority.

Lay-by

Lay-bys should be provided with a 2.5 per cent crossfall. Channel gradients should not be flatter than 0.8% (1 in 125).

Shared Surface

For roads surfaced with block paving a 2.5 per cent crossfall should be provided throughout with a minimum longitudinal fall of 1.25% (1 in 80).

Junctions

The maximum gradient, rising or falling, on the final approach of a minor road at a junction should be limited to 2 per cent for a minimum distance of at least 12 metres from the major road. At other locations the gradient of the minor road over the X distance at a junction should not exceed 4%.

Length of Maximum Gradient

The lengths of gradients which are near to the maximum permitted gradient should be kept as short as possible and should not include any horizontal curves within them, except where the radius of the horizontal curve is very large.

Vertical Curve Length

The length of a vertical curve is based on the difference in gradient multiplied by the factor K. See Table 3 on page 78 for the appropriate K value.



(e) Vehicle Clearance**Vertical Clearance**

The minimum headroom for any structure, other than a footbridge (which must be constructed with a 5.7 metres clearance), must be 5.3 metres when spanning a Strategic or main Road and 5.1 metres for all other roads, including access through pends where servicing is required.

Generally, 2.1 metres clearance will be all that is required for an access, or covered parking area, which will only be used by private cars, but care should be taken to ensure that refuse vehicles can safely service the area without blocking the adjacent road. Consideration must also be given to changes in the longitudinal profile of the driving surface approaching a vertical clearance and how vehicles negotiate the vertical restriction in comparison to a simple level approach and exit to a vertical clearance.

Horizontal Clearance

A horizontal clearance of 0.5 metres should always be provided between the edge of the carriageway and any vertical objects such as signs. Where the crossfall on the carriageway exceeds 4% this clearance should be increased to 0.6 metres.

Figure 17 Horizontal Clearance

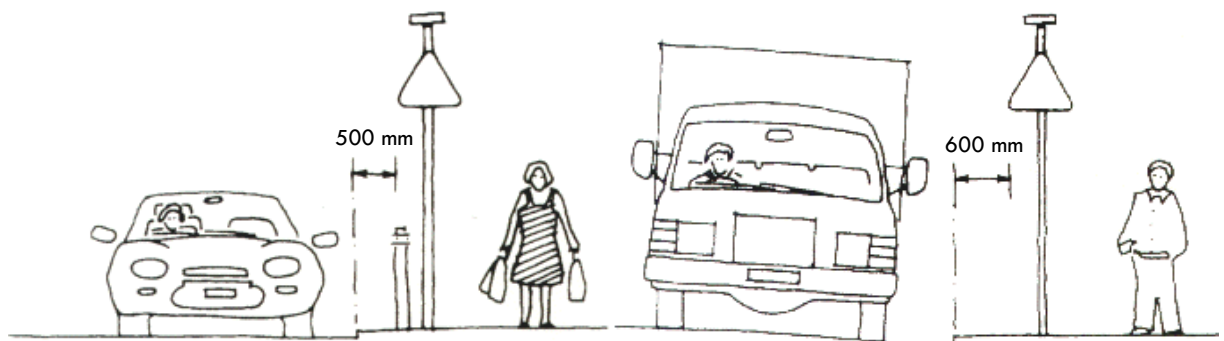
**(f) Turning Areas****Loop Road Preferences**

Turning areas are referred to in [Designing Streets](#) (page 37). The developer should demonstrate provision of servicing route so that service vehicles do not need to reverse. Wherever possible this should be achieved by the provision of roads forming loops thus avoiding the need for turning areas and minimising mileage for delivery, service and public transport vehicles, alternatively, reducing development impact so that all aspects are accommodated.

Part 3

ROADS DEVELOPMENT GUIDE

Provision

In general where roads are not provided in a loop form and culs-de-sac are used in a layout, they should terminate in turning circles. Where lack of space precludes the creation of a turning circle, turning heads may be substituted. However it should be noted that over-development of a site to the detriment of such infrastructure requirements is likely to be unacceptable.

Dimensions

The dimensions of turning areas should suit the characteristics of the largest vehicles to use the facility regularly. In residential roads these will normally be refuse collection vehicles, while in industrial/commercial development it may be necessary to cater for 15.5 metres long articulated vehicles or 18 metres long drawbar trailers. The turning areas detailed in Figure 18 are based on the turning circles of these vehicles between kerbs. The length of any hammerhead may be extended from the minimum values shown in Figure 18 at the discretion of the Local Roads Authority.

Figure 18

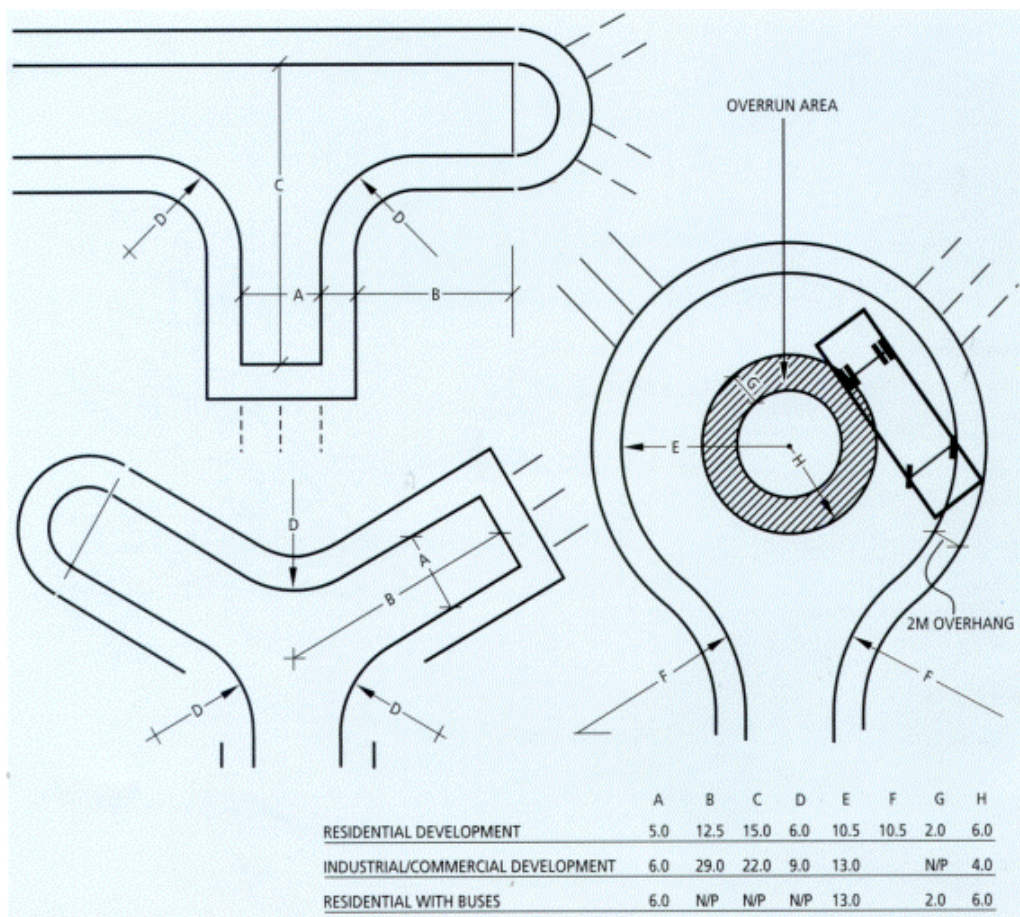

Overhang

Where there is no adjacent footway, turning areas should be provided with a 2 metres wide verge or margin to allow for any overhang of vehicle bodies when manoeuvring.

Self-Policing

Parking in turning areas should be discouraged by locating turning circles well clear of frontage development, or by arranging for premises and designated parking bays to take access via the turning area.

Environmental Design

In residential areas the use of less formal shapes for turning heads may be acceptable as illustrated in Figure 18 as long as the shape used still incorporates the basic turning head dimensions which must be detailed on drawings submitted for construction consent.

(g) Provision for Public Transport

Provision for Buses

Amendments including facilities on existing roads to accommodate bus penetration may be required, at the developer's expense. All details in relation to the provision of bus operation should be obtained at an early stage by consultation with the Local Roads Authority.



Scottish policy is:

- ◊ to provide the environment for bus to act as an effective economic enabler by providing competitive, high-quality public transport;
- ◊ to enable bus to provide an effective alternative to the car by improving reliability, average bus speed and encouraging improvements to the quality of services and infrastructure;
- ◊ to encourage investment in more efficient vehicles that produce less greenhouse gases and contribute to the targets in the Climate Change (Scotland) Act 2009;
- ◊ to link communities, people, places of business and employment and essential services through encouraging the maintenance and development of the bus network in Scotland.



Public Transport

Developers should be aware of the existing structure of the public transport network, including proposed additions or alterations. Measures can be provided in the design of a development to encourage the use of the public transport network by ensuring that it is readily accessible. This will require direct footpath and cycleway links to existing or proposed bus and light rail stops and railway stations. Direct vehicular access may also be made available to permit dropping off and picking up, where space and demand exists. For exceptionally large developments, developers may be asked to provide a new station within the rail network.

Bus routes should have a minimum road width of 6.0 metres.

For details of bus stops and other public transport facilities information is available in [I.H.T. Guidelines for Planning for Public Transport in Developments](#) [🔗](#).

Figure 19 Bus Turning Area (2 metre overhang required)

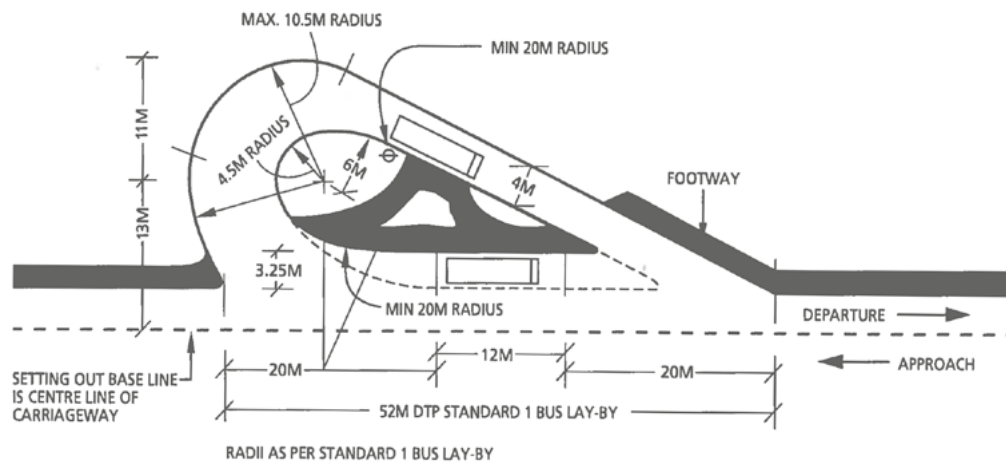

Bus Stop Provision

Good public transport provision should be available at the initial phase of any new development, either by linking to existing networks or by establishing new routes and should therefore be discussed with local transport operators and the Local Authority's Transportation manager at an early stage.

Designing for Bus Passengers

When a new bus stop is likely to be used by more than 50 passengers a day, shelter facilities should be provided. Where real-time information services can be made available, such facilities should also be considered.

All details in relation to the provision of bus stops should be obtained at an early stage by consultation with the Local Authority's Transportation manager or nominated representative.

3.1.4 Pedestrians and Cyclists



(a) Provision for Vulnerable Users

A network of routes, which are safe and convenient, should be established to cater for the needs of the pedestrian, including those with a disability and cyclists.

An audit which indicates how due regard to disabled road users was considered is required as part of the RCC submission.

Cycle routes can comprise either cycle tracks (for pedal cycles only or pedal cycles and pedestrians), or cycle lanes, (part of the carriageway reserved for the exclusive use of pedal cycles).

(b) Pedestrian Provision

Pedestrian Network and Routes

Pedestrian movements should be made as convenient, safe and pleasant as possible by careful attention to the design and layout of pedestrian routes. The pedestrian network should reflect nature desire lines and be more attractive for pedestrians to use than the vehicular route. The provision for cyclists should be examined at the same time as the provision for pedestrians as the two can often be combined.



Definition of Footways and Footpaths and Bridleways

The [Roads \(Scotland\) Act 1984](#) defines a “footway” as a way, over which there is a public right of passage by foot only, which is associated with a carriageway and a “footpath” as a way, over which there is a public right of passage by foot only, which is not associated with a carriageway.

Pedestrian Crossings Considerations

Particular attention should be paid to the locations at which pedestrian routes cross the carriageway (eg at road junctions) so that footway and footpath users are not exposed to unappreciated dangers. Judicious use of hard and soft landscaping can guide pedestrians to suitable crossing points and help prevent children running directly onto the carriageway and consideration should be given to the possible need for crossing facilities adjacent to shops, clinics, community facilities and other generators of pedestrian traffic. Desire line should be considered and tighter radii of the carriageway kerblines (if kerbs exist) are helpful in encouraging direct connections for users on foot.

Pedestrian Crossings

At designated pedestrian crossing points, kerbs should be dropped to permit easy access to and from the carriageway for pedestrians with prams and wheelchairs. Kerb upstands range from 0 mm to 10 mm at such crossings

Grade Separated Pedestrian Crossings

Where both vehicular and pedestrian flows are very high, footbridges and underpasses may be appropriate for carriageway crossings. They should be designed to be obviously more convenient, pleasant and safe to use than any alternative route. This will often involve elevating or depressing the carriageway to ensure that footways and footpaths have minimal changes in level.

Controlled Pedestrian Crossings

Where grade separated can not be justified or provided it may be necessary to balance the competing demands of pedestrians and vehicles by providing a controlled crossing, eg a pelican crossing or pedestrian stage in traffic signals.

Tactile Slabs at Controlled Crossings

A tactile surface should be provided on the approach to all controlled crossing points. Further details of the layouts and use of tactile slabs are given in the [DfT Guidance on the Use of Tactile Paving Surfaces](#).



Enhancement of At-Grade Uncontrolled Pedestrian Crossings

Uncontrolled crossings may be necessary where the path and road networks cross but the flows are not high enough to justify a controlled or grade separated crossing. These crossing points may be enhanced by introducing traffic calming, thereby making it easier for pedestrians to cross the road and where possible a tactile surface should be provided in accordance with D.E.T.R. [Guidance on the Use of Tactile Surfaces](#) .

Pedestrian Routes on Arterial Roads

Where pedestrian routes of necessity run beside arterial Roads, separation from the carriageway by either a hard or soft landscaped strip, at least 2 metres wide may be advisable, in the interests of road safety and of improving the environment of the road. Reasoning should be included in the quality audit.

Width of New Footways

There is no maximum width for footways; widths should take account of pedestrian volumes and composition. In locations with a high 'place' function footways should be of sufficient width to cater for peak demand without causing crowding and the risk that people will be pushed into the carriageway.

Table 4 specifies the required widths of footways which depend upon the level of pedestrian activity. These widths may require to be increased to cater for high pedestrian volume.

Table 4 Footway Widths

Frontage Development	Width (metres)
None	2.5 - 3.0*
Industrial	2.0 - 5.0
Residential	2.0 - 3.0
Local Shops	4.0
Major Shops	5.0

* *minimum 3.0 metres for arterial road*

Width of New Footpaths

Table 5 on the following page details appropriate widths for footpaths and pedestrian areas intended for adoption. These widths may require to be increased to facilitate maintenance of the footpath and/or underlying services.

Table 5 Footpath Widths

Type of Footpath	Width (metres)
Minor pedestrian routes	2.0*
Major pedestrian routes	3.0
Shopping precinct	3.0
Footbridge	2.5
Underpass (2.3 headroom)	2.5

* May be inadequate for maintenance purposes in order to accommodate services

Obstacle to Pedestrian Desire Lines

Any street furniture which is to be provided, such as planters and litter bins should be located in such a way as to maintain a 2 metre wide obstacle free footway. Local narrowing to 1.4 metres over a 3 metre length may be permitted to accommodate street furniture, however, furniture should be reduced to a minimum and grouped together outwith the pedestrians' desire lines of movement (Figure 21).

Reduced Footway Width at Refurbished Buildings

Where existing buildings are being rehabilitated or modernised it may be permissible, with the approval of the Local Roads Authority to reduce the footway width.

Pedestrian Priority at Vehicle Access

Where vehicular access to premises is taken across a footway, the ramped portion should be confined to the front 600 mm that is immediately adjacent to the carriageway, thus emphasising the pedestrians' priority. The short ramp adjacent to the dropped kerb also encourages a reduction in the speed of vehicles crossing the footway.

Desirably, gradients on footways and footpaths should not exceed 5 per cent, with a nominal maximum of 8 per cent. They should be constructed with maximum crossfall of 2.5 per cent. Steeper gradients may occasionally be permitted, subject to the provision of a handrail on at least one side and rest platforms at 10 metre intervals.

Figure 21 Obstacles to pedestrian desire lines

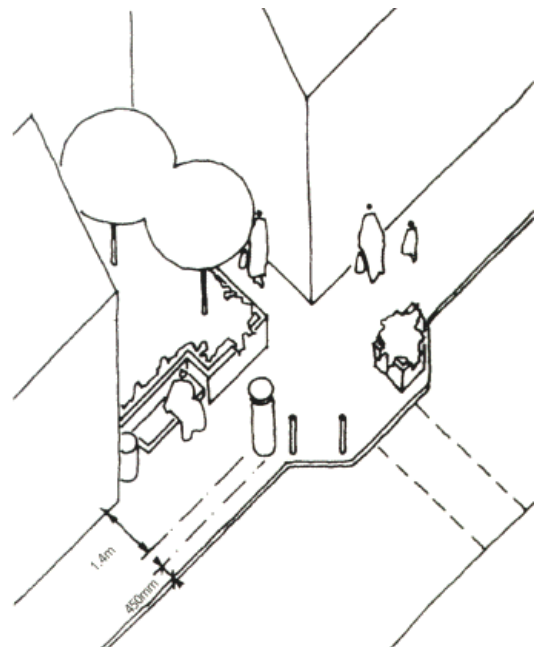

Steps or Ramps on Footway

Pedestrian ramps should have a maximum gradient of 10 per cent. Ramps with gradients of between 5 per cent and 8 per cent should be no more than 6 metres long and steeper ramps a maximum of 3 metres in length. Landings should be provided at the top and bottom of every ramp, and at every turn within a ramp. Stepped ramps should be avoided wherever possible and must not provide the sole means of pedestrian access or be used on wheelchair routes.

Steps will not normally be adopted as they pose problems not only for prams and wheelchairs but also for mechanised maintenance. They should therefore never form the sole pedestrian route and wherever practicable steps should be avoided. However, since some people find walking on any sloping surface difficult or impossible, steps may be provided in addition to long ramps where they are essential to meet the requirements of a pedestrian desire line. Each flight should rise a maximum of 1.2 metres and comprise between three and twelve uniform steps. Longer flights should be split into sections by landings. Steps should have 0.3 metre permanently nonslip treads and a minimum clear width of 1.4 metres.

Street lighting should be provided to light steps adequately and provision of Winter maintenance grit boxes should be made at the top of all steps.



Landings

Landings on ramps and stairways, and rest platforms provided adjacent to footpaths and footways, should preferably be 2 metres long x 2 metres wide with an absolute minimum dimension of 1.35 metres by 1.35 metres.

Handrails

Refer to DfT Traffic Advisory leaflet [6/02 Inclusive Mobility](#).

Handrails should be provided at both sides of steps (or centrally on steps a minimum of 3 metres wide) so they can be used by either hand. Handrails should comprise 50 mm diameter, galvanised, mild steel tube and must be securely fixed. They should be set 1 metre above a ramp and 0.85 metres above the tread of a step. They should extend at least 0.3 metres horizontally beyond the top and bottom of a ramp or flight of steps and should be returned at each end. Handrails can sometimes be difficult for people to grip and the most comfortable cross section for a handrail is circular with a diameter of 45 or 50 mm. Handrails where fixed to a wall should have a gap of 45 mm between the rail and the wall. Free standing handrails should be complemented with a lower rail set not more than 0.3 metre above the walking surface.

Disabled and Equalities Requirements

Refer to UK Government guidance: [Inclusive Mobility 2005](#).

Disabled Access to Buildings

For disabled access to buildings, ramps should be incorporated off road. Where this is not possible then ramps on existing footways may be permitted for refurbishment of existing buildings as per Figure 20 and Table 6. Reference should be made to the Technical Standards (Scotland) Buildings Regulations and DfT advice [6/02 Inclusive Mobility 2002](#).



The categories of buildings requiring disabled access are:

- (1) Home*
- (2) Institutional
- (3) Offices
- (4) Any Shops above 500m²
- (5) Assembly place, eg pubs, halls
- (6) Industrial

* Where a house contains a Surgery, ie Doctor, Dentist, then the requirement applies.

Table 6 Footway Ramp Widths

	W(m)	O/A Width (m)			
		Type A	Type B	Type C	
Non Shopping	1.40	3.20	3.20	2.25	Desirable Minimum "W" on Ramp* Absolute Minimum**
		-	3.00	-	
		3.00	2.80	2.05	
Local Shopping	2.80	4.60	4.60	3.65	Desirable Minimum "W" on Ramp* Absolute Minimum**
		-	4.40	-	
		4.40	4.20	3.45	
Major Shopping	3.50	5.30	5.30	4.35	Desirable Minimum "W" on Ramp* Absolute Minimum**
		-	5.10	-	
		5.10	4.90	4.15	

* On the through ramp layout original footway level is preferred to have minimum width. However, marginal o/a width reduction possible if ramp is made to provide minimum width with 1m footway alongside.

** Absolute minimum achieved with min edge width 400m reducing to 200m in Type A & B, and 600 to 400mm for Type C.

Figure 20 Ramp Dimension

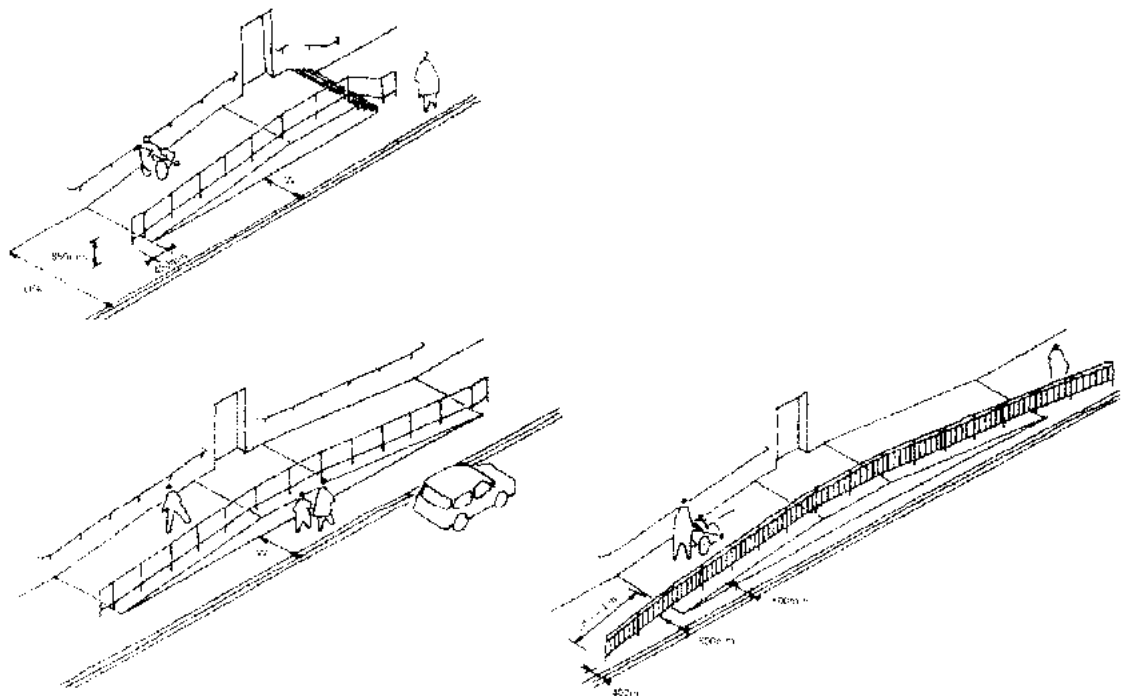

Vertical Features

Generally free standing objects such as bollards and seats should be 1 metre high so that they are more obvious and can be more readily seen at waist height than at knee height. Where possible they should also be in a contrasting colour to further highlight their position. Consideration for these details require to be demonstrated through a disability audit.

(c) The Cycle Network

Objectives

A cycle network should be established to serve the needs of cyclists with the main objectives being the following:

- (a) *Cyclists should be segregated from large volumes of vehicular traffic, especially where roundabouts are located, or fast moving traffic (>40mph).*
- (b) *Vehicle speeds should be reduced where there is a large number of cyclists.*
- (c) *Safe crossing points should be provided for cyclists at roads with major traffic flows.*

Further Advice

Further and more comprehensive details of provision for cyclists can be obtained from Transport Scotland's publication **Cycling by Design** [🔗](#) (Revision 1, June 2011).

Cycling Facilities

The following definitions apply to facilities for cyclists:

- (i) *A safer signed route is a route signed along minor roads, cycle tracks and cycle lanes.*
- (ii) *A cycle track has the same meaning as described in the **Roads (Scotland) Act 1984** [🔗](#). It is thus a 'road' for cyclists or cyclists and pedestrians segregated from the carriageway.*
- (iii) *A cycle lane is a lane provided for cyclists within a carriageway.*

Collectively these facilities can be used to form a cycle route.



(d) Geometric Standards for Cycle Routes

Dimensions

To allow the free movement of cyclists certain standards will require to be met and typical dimensions are given in Table 7 on page 94.

Surface

The surface of all cycle routes should preferably be a smooth non-skid wearing surface with a different colour from any adjacent traffic surfaces. Where the cycle route is part of the carriageway then particular attention should be paid to the surface condition on the inside edge where cyclists ride.

On Road Cycle Lanes

Cycle lanes should be 2 metres wide on busy roads, or where traffic is travelling in excess of 40 mph. A minimum width of 1.5 m may be generally acceptable on roads with a 30 mph limit. Cycle lanes less than 1.2 m width are only recommended at lead-in lanes to advanced stop lines where there is insufficient width for wider lanes.

The ideal minimum widths required for vehicles to overtake cyclists in comfort given in LTN 2/0838 are:

Car passing at 20 mph - 3.8 m

Car passing at 30 mph - 4.3 m

Bus/HGV passing at 20 mph - 4.6 m

Bus/HGV passing at 30 mph - 5.05 m

These are not necessarily lane widths, however. If traffic flows are generally light enough for vehicles to pass cyclists fairly readily by moving at least partly into the opposite lane then the overall carriageway width will be available. Lane widths of 3 m or less will make it less likely that drivers will try to squeeze past cyclists without pulling around them.

If traffic speeds are higher and motor vehicles are not able to move into the opposite lane to pass cyclists with comfort, then cycle lanes may be justified so that excessive lane widths are not provided, which would otherwise encourage higher speeds. Where there is more than one lane in either direction, some authorities have divided the carriageway into unequal lanes, giving more space on the nearside lane to assist cyclists.

Crossfalls

A standard crossfall of 2.5% is required generally but may be increased over short lengths, such as superelevation being applied on a tight bend.

Minimum Radius

The minimum desirable radius for a bend on a local cycle track is 15 metres. At junctions where turning speeds should be low, junction radii may be designed down to an Absolute Minimum radius of 4.0 m.

Gradients

Generally, cycle track gradients should not exceed 3% but a gradient of 5% is allowed over a maximum length of 100 metres and 7% over a maximum length of 30 metres. Gradients of 7% or more are not recommended except over very short lengths.

Table 7 Dimensions for Cycle Routes

Constraints at Boundary	Segregated			Shared
	Footway/ Footpath	Cycle Track	Verge	
Open Site or 0.5 m verges	1.2 m	1.5 m	-	2.5 m
Wall, bushes etc on kerbline	1.2 m	1.5 m	-	2.7 m
Carriageway on cycle track side	1.2 m	1.5 m	0.5 m	3.2 m

Road Crossings

Care must be taken where a cycle route crosses a road and that adequate visibility is provided, otherwise barriers or posts will be required to slow cyclists down. Where cycle routes cross pedestrian routes then it may be necessary to introduce some form of traffic calming, such as a footway rumble strip, on the cycle route itself to alert cyclists that pedestrians are likely to be crossing ahead.

Grade Separated Crossings

Grade separated crossings where facilities have been provided for the mobility handicapped will also be suitable for cyclists. However, where subways are concerned a clear headroom of 2.5 metres is required as a desirable minimum and on bridges a parapet height of 1.5 metres will be required.

Roundabouts

Care should be taken in the installation of roundabouts where there is a large number of cyclists using the junction as they often experience difficulty in using roundabouts. Further information and guidance on junction control may be obtained from the appropriate technical memoranda or advice may be given by the Local Roads Authority.

Traffic Calming

Where the use of the road by the cyclist is high, ie where a cycle route uses residential roads, or traffic calming has been added to an arterial road, then it may be appropriate to consider alterations which would assist the cyclist.

3.1.5 Servicing

(a) Off Road Servicing

All development should be designed such that premises can be serviced from vehicles parked off the main carriageway without adversely affecting road safety. For residential and small commercial properties, servicing can generally be satisfactorily undertaken via access driveways but, for major commercial and industrial premises, a separate service area should be provided.

(b) Range of Servicing Provision

Service areas range from single bays to sophisticated structures incorporating loading bays and mechanical goods handling equipment. The size and layout of all service areas should be such that all vehicles can enter and leave in a forward gear and do not need to reverse on the public road. Developers will be required to prove through swept path analysis that all the necessary manoeuvres can be successfully completed (Figures 22).

Figure 22 Refuse vehicle swept path envelope

FTA Large rigid design vehicle Side road stub

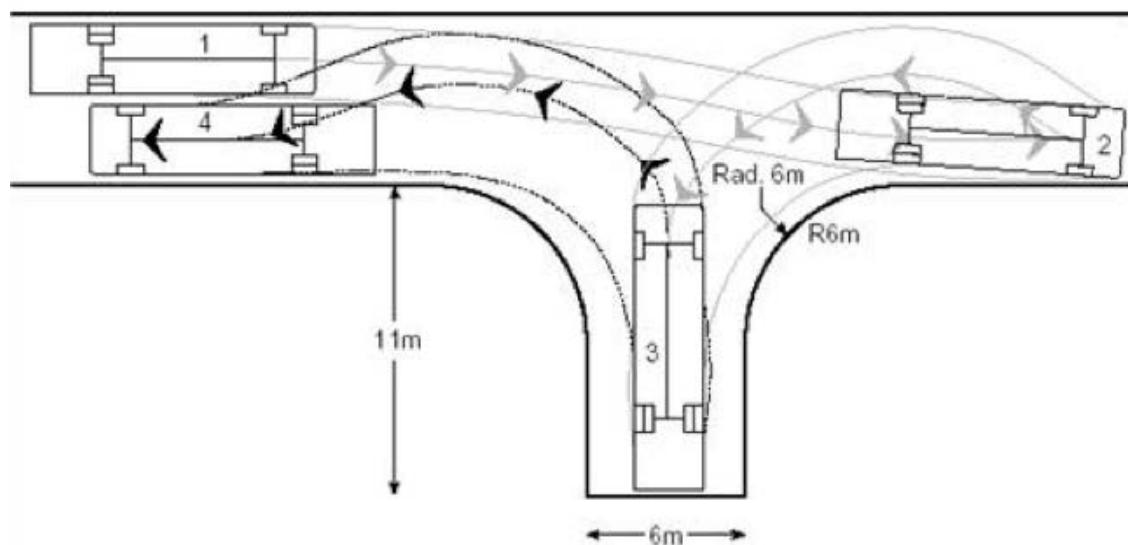

(c) FTA Guidance

Advice given in the Freight Transport Association's (FTA) guide 'Designing for Deliveries' will assist in producing an internal layout suitable for the type of goods vehicle likely to be servicing the development.

(d) Interpretation of FTA Guidance

The standards given in the FTA guide are representative of the standard driver in standard conditions and should not be compromised. Use of the recommendations will ensure that all drivers and vehicles can manoeuvre in the service yard within reasonable safety margins.

(e) Service Yard Design

Service Yards should be designed to allow access from the adjacent road without causing delay to through traffic, even if a vehicle is waiting to exit. Loading bays should be provided to allow goods vehicles to load and unload in a convenient and safe manner. Most of these loading bays will be arranged to allow access to the rear of the vehicle and consequently adequate space must be provided to allow the goods vehicles to turn and reverse into the loading bay. The total depth of the bays can be reduced where vehicles are parked at an angle with a saw-tooth loading deck but this arrangement is appropriate only when used with a one-way circulation system. Drivers should not incur blind spots when manoeuvring in the yard (Figure 23).

Figure 23 Reversing blindspots

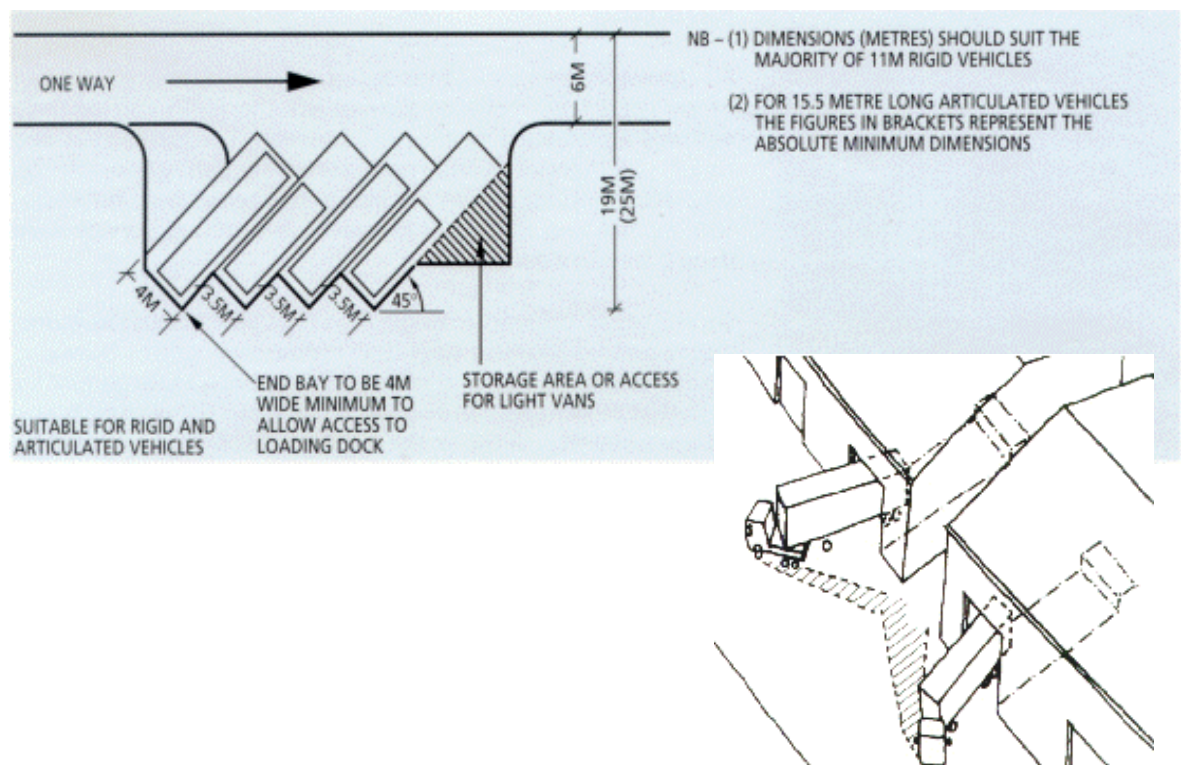

(f) Loading from Parallel Bays

Where vehicles are to be loaded or unloaded while parked parallel to the kerb in service roads, parking bays, 3 metres wide and at least 3 metres longer than the vehicles using them, should be clearly designated. The width of the service road should be increased accordingly. Bay widths should be increased where side loading of vehicles by fork lift trucks is contemplated to give a clear width of 3 metres between adjacent vehicles (Figure 24).

Figure 24

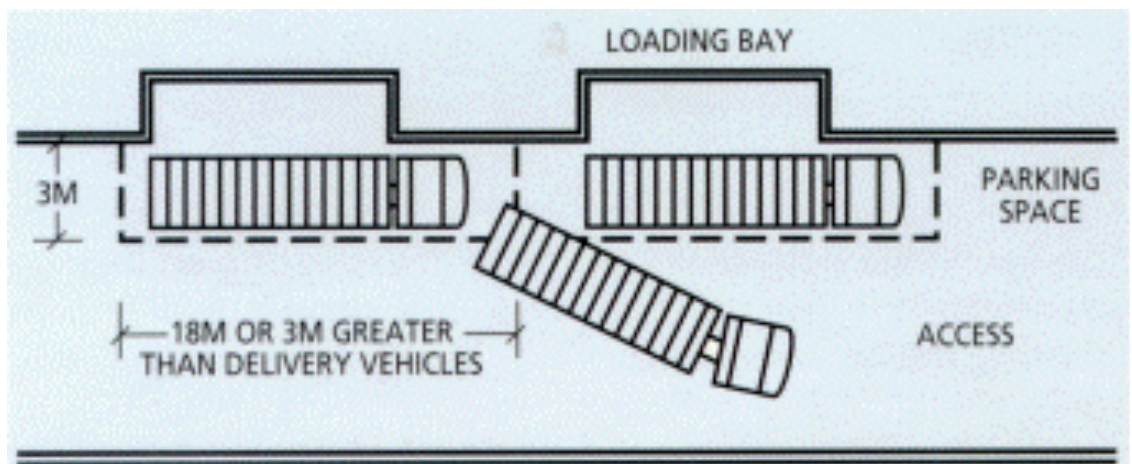

(g) Refuse Collection

Where Standard issue wheeled bins or sack collection are used, a designated collection area is required (ie nearest kerbside or other place agreed by the Council).

Where communal waste and recycling facilities are provided, the maximum distance from bin storage area to refuse vehicle should be no more than 10 metres and should incorporate a level hard surface and dropped kerbs where appropriate to aid correct manual handling techniques. There should be an available width of 1.5 metres and head room of 2 metres to enable bins to be manoeuvred safely.

The refuse collection vehicles are a maximum of 12 metres long and 2.54 metres wide (excluding mirrors). The working length of the vehicle should taking account of the size of the bin and space to allow operatives to stand clear of the bin whilst on the lifting equipment should be 16 metres (Figure 24).



Access roads should be built to withstand a gross vehicle weight of 32 tonnes with an axle loading weight of 11.5 tonnes. The turning circle requirement should be in the region of 24 metres or a suitable swept path hammer head detail. Refuse collection vehicles should not be expected to carry out a lengthy reverse manoeuvre if at all possible.

(h) Overnight Parking

Provision must be made in commercial and industrial developments for the overnight parking, off the public road, of all associated vehicles. Where large numbers of servicing movements are anticipated, consideration should be given to the provision of parking bays for vehicles awaiting access to loading bays. It is essential that these vehicles can park at locations which will not interfere with the safe manoeuvring of any other vehicles. The dimensions of the parking bays should be similar to those of the loading bays but reference should be made to '*Designing for Deliveries*' published by the FTA for layout details. Provision must also be made for car parking as detailed in *Chapter 7*.

3.1.6 Statutory Undertaker Services

(a) Consultation

The provision of statutory or other services laid underground constitutes a basic element of development design. It is essential that the Statutory Undertakers, who provide such services are consulted during preparation of design briefs, in order that their requirements can be co-ordinated in the design and a balance struck between their needs and other objectives. Refer to [NJUG Publications](#) .

Developers should be aware that the local Water Authorities have no statutory responsibility for the disposal of road surface water. Connection of road water into a surface water/combined sewer will only be allowed through agreement with Scottish Water. This must be considered up-front to confirm the proposed road drainage system and as part of the planning process.

(b) Services Located in Roads

In the interests of both the Statutory Undertakers and other providers such as district heating schemes, and their consumers, all mains and services serving more than one proprietor should be located in land which is both publicly maintained and readily accessible. It has been recognised that these criteria are best met by public roads and, as well as making provision for pedestrian and vehicular movement, it is therefore a function of most roads to provide routes for underground services.



The key driver should be that all services are provided such that they can be maintained without damaging or affecting the road design life. Ducting is considered an acceptable method of providing denser utility provision which permits upgrades without extensive road disruption.

(c) Services in the Carriageway

Regards sewers, early consultation should be made with the Local Water Authority regarding their provision, in accordance with the [Sewerage \(Scotland\) Act 1968](#). Early consultation should include surface water sewers for the drainage of roofs and paved areas within the curtilage of premises, and the foul water drainage system. All services other than sewers, and occasionally water mains, should be grouped in 'service strips' located within the limits of the footways, verges and adoptable footpaths with a minimum of service connections across the carriageway.

Other utilities will not normally be placed under carriageways, with the exception of road crossings. This is due to the need to ensure that the road is not compromised as a result of inability to provide proper compaction, or due to collapsing ducting and the likes. Also, there is a need to ensure that the utility is not at risk of damage due to vehicle loading - either during the construction or operation of the road.

Where service crossings are required within carriageways, there should be a local deepening to provide 900mm cover from the finished road surface to the top of the service. Alternatively, protection (such as concrete surround or cover) can be applied, however it should be noted that this can give rise to future maintenance issues, and this should be agreed with the Statutory Undertaker at early stages. All services should be individually ducted at increased depths in accordance with the requirements of the Statutory Undertakers as directed by the Local Roads Authority.

Crossings of narrow residential roads should be located at passing places to minimise disruption to traffic flow during maintenance/repair works.

(d) Services in Service Strips

The width of a service strip will depend on the number and type of premises served. All domestic services (gas, electricity, lighting, water and telecoms) will normally be accommodated in a maximum 2 metres wide reservation and Figure 25 shows typical positions. This diagram is, however, only a guide and does not absolve the designer from negotiating with each Statutory Undertaker at the earliest possible stage. Special arrangements will require to be made where a footway is less than 2 metres wide and local widening in excess of 2 metres may be necessary to accommodate access chambers or where roads have tight bends.

Figure 25 Services Under Footway

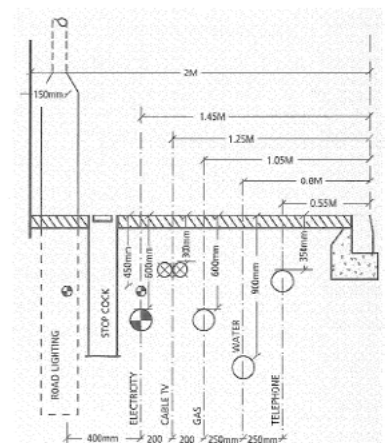

(e) Services in Shared Surfaces

In shared surface layouts, all services should continue to be located in land eligible for adoption by the Local Roads Authority. Where the development calls for the use of a shared surface road construction, particular attention must be paid to the placement and provision of service strips. Where possible, service strips should be located outwith the running surface, and consideration should be made for their placement within a landscaped zone adjacent to property garden areas. If locating service strips within the running surface, care should be taken to ensure that it is situated within an area which is subject to less traffic where possible, eg to the side of the surface. Service strips should be maintained at a width of 1.8-2.0m, with an absolute minimum of 1.5m permissible for shorter lengths or to accommodate road geometry or restrictions.

In the event that the service strip must be located within the shared surface running area, early consultation with the utility providers is essential. A modified layout for the placement of services and/or a modified road construction detail may be required. Typically, the standard arrangement for the placement of services does not lend itself to situation where the service strip is located within a running surface zone of a shared surface; the typical depth of utilities is likely to result in the service being situated within the road construction layers. This gives rise to concerns over both the integrity of the road, and the protection of the service, with particular issues being raised surrounding the adequate compaction of construction layers immediately above the service.

Where a service strip must underlie a Shared Surface road, under no circumstances should any manhole be located within the 3.5 metres wide running width of the shared surface unless an alternative vehicular access is provided. Manholes should preferably not be located in the service strip but may be located within parking areas or widened areas within the total road width, by agreement with the Statutory Undertakers.

Engagement should be sought with the Statutory Undertaker and the Local Authority to determine whether the services should be installed at an increased depth, or whether a modified road construction detail is used.

Care should be taken when specifying the use of geogrid or geotextile in lieu of additional depth of construction material, as the maintenance and access arrangements for servicing utilities located beneath these elements must be taken into account.

Where service strips are under private control, they must continue to be maintained, and agreed maintenance methods determined. This may therefore require a wayleave agreement.

(f) Street Furniture and Lighting Columns

All street furniture should always be located within adopted or prospectively adoptable land and normally be located at the rear of footpaths/footways or recessed behind them and no furniture or structures should obstruct any road junction sight line. Conversely, no services other than road lighting cables should be located within 0.5 metre of the rear of the footway to allow for lighting columns and joint pillars or other street furniture. Guidance regarding the provision of road lighting is contained in section 3.4.11.



(g) Service Strip Remote from Carriageway

Where service strips are not located adjacent to carriageways their width must allow for access by mechanical plant and/or vehicles for maintenance or repair. In all cases there must be a permanent and continuous demarcation of the boundary between the service strip and any adjacent private property (eg by a fence, wall or concrete edge kerbing).

(h) Maintenance and Emergency Access

Ready access must be available at all times to all parts of service routes for maintenance and in cases of emergency. Lorry access will be needed to some places such as manholes, electricity sub-stations, telecom junction boxes and gas governor house installations; and the Statutory Undertakers requirements for such facilities should be ascertained at an early stage. They should be positioned so as to minimise disruptions to vehicle and pedestrian access when service maintenance is being carried out, whilst ensuring that access to services will not itself be obstructed by parked vehicles. Special consideration in this respect will be necessary where services run beneath or adjacent to single lane carriageways and parking bays.

(i) Hydrants

The position of all hydrants should be agreed with the Firemaster and Water Authority. Hydrants should not be located where vehicles are likely to park.



(j) Surface Finish of Service Strip

The surface finish of all service strips must form an integral part of the environment and be acceptable for general maintenance by the Local Roads Authority. Service strips should be protected when there are risks from damage from occasional overriding by vehicles.

(k) Planting and Service Strips

It is essential that any trees adjacent to service strips are located so that their roots will not damage services underground or be damaged themselves during the maintenance of such services.

Ducting services past tree roots can provide normally an acceptable compromise for all parties.

Advice should always be sought from the Statutory Undertakers when considering planting in the vicinity of services. Refer to [NJUG Publications](#) .

(l) Road Opening Consultations and Consents

The developer is responsible for contacting the Statutory Undertakers regarding the position of, and connection to, any existing underground plant. In all cases, the necessary Road Opening Permit under the Roads (Scotland) Act, 1984 or Permission in Writing under the New Roads and Street Works Act, 1991 must be obtained from the Road Authority before any excavation is undertaken in a public road.

3.1.7 Rural Areas

(a) Introduction

The main part of the Guidelines considers the urban situation and its immediate environs. However, areas of a rural nature should be considered differently.

(b) Hierarchy

Circumstances when rural standards may be applied should be discussed early in the planning stage and may include:

- ◊ *developments adjacent to and accessing directly onto an existing unrestricted road;*
- ◊ *developments which are likely to remain remote from existing settlements for the foreseeable future and require a new road that ultimately accesses to the existing unrestricted road network.*

Rural areas can be treated similar to the urban areas but the significant difference will be to ensure that adequate visibility is provided on roads which are subject to speed limits which are in excess of 30mph.

Required provision for public transport and footways should be referred to the local authority.



(c) Road Widths

Introduction

Consideration will also require to be given to road widths in a remote rural situation. The basic road widths for Residential Roads, within this document, are based on user defined swept path analysis and this remains the case. However, consideration must be given to the additional traffic flow which will be generated by the development on the existing surrounding road network.

Dwellings/Traffic Flow/Road Widths

The developer will have to demonstrate the level of the existing traffic flow and the likely peak generated flow created by the new development and depending upon the new total flow the following new road types and minimum widths are suggested as likely to be appropriate.

Adjacent future development identified through either Master planning or Local Development Plans need to be considered such that developments are adaptable to these future requirements.

Developing on Existing Roads

Where a development is proposed on a road which does not meet these criteria then the developer will be required to widen the road along the frontage of the development or the access road to the development to the appropriate width and provide new and/or passing places where required to mitigate the development traffic. Note this requires statutory consents such as a Section 56 [Roads \(Scotland\) Act 1984](#) .

Passing Places on Existing Roads

On an existing narrow rural road, passing places should be constructed to enable user defined traffic to pass. The design of such a passing place should consider functionality against a balanced view of placemaking aspirations and a presumption against urbanising the countryside.

All passing places should provide a minimum overall width of 5.5 metres. Locating passing places is dependent on gaining the maximum benefit balanced with planning legislation.

Where possible, it is advisable to have intervisible passing places, adjacent passing places should be placed on alternate sides of the road or on corners where maximum benefit is gained.

Locating passing places on bends on existing roads is advisable to assist vehicle conflict where reversing or anticipating and negotiating passing vehicles is more difficult.

Advice on specific numbers and locations should be sought from the Local Authority in advance.



Passing Places on New Access Roads

All passing places on a new access road should be constructed to the dimensions given in Figure 26. All passing places should be intervisible. Adjacent passing places should be placed on alternate sides of the road. Advice on specific numbers and locations should be sought from the Local Authority in advance.

Figure 26
New Access Passing Places

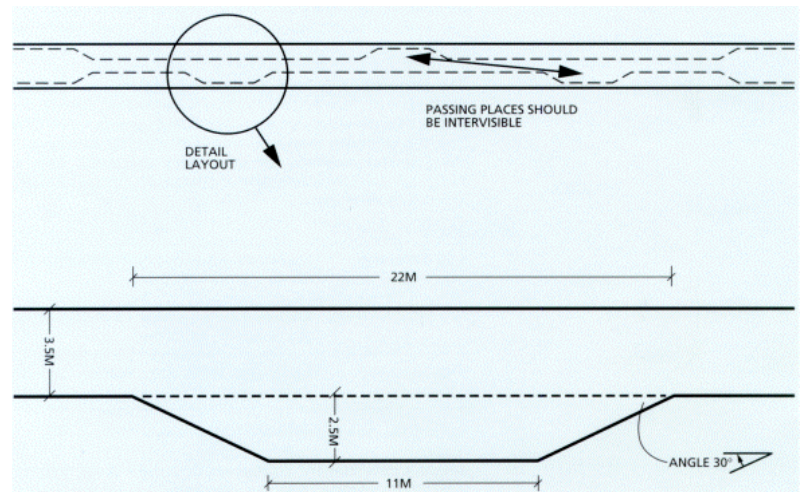

Visibility Splay

Visibility splays are calculated in the same manner to the method used in the Urban area for the X distance, but the speed which the Y distance is based on will be higher. In certain circumstances, the design speed for the road will not be known and it may be necessary to measure the actual speed at which the traffic is travelling in order to calculate the Y distance.

Speed Visibility Relationship

Where the traffic speed can be measured, the 85%ile speed should be measured in wet weather and then this measured speed can be compared against the speed, or the next highest speed in Table 8, which then gives the Y distance. If there is not an opportunity to measure the speed then Table 9 should be used and the Y distance obtained from the appropriate speed limit.

Table 8 Wet Weather - 85 Percentile Speed

Major Road Speed (mph)	75	62	53	44	37.5	30
Y Distance (m)	295	215	160	120	60	43

Table 9 Speed Limit

Speed Limit (mph)	70	60	50	37	30
Y Distance (m)	295	215	160	59	43

Access Points

Where a development is proposed from a road with a high traffic flow which is not subject to a 30 mph speed limit, particularly in more rural areas, and the access is to be gated then the gate should be set back by at least 6 metres so that cars entering or leaving do not require to stand on the carriageway while the gates are opened and closed. All gates must open inwards towards the site. If the development is to cater for larger vehicles or is a field access when it will be necessary to set the gate back by a distance which will accommodate a turning manoeuvre appropriate for the vehicles which are likely to be using it. On roads with a low traffic flow this requirement may be waived at the discretion of the Local Roads Authority.



Consultation

Developers are advised to consult the Local Roads Authority at an early stage to determine the road requirements of the development.

3.1.8 Street Planting Considerations

This aspect should be considered in conjunction with any SUDS design.

(a) Visual Aspects of Housing Developments

It is important to the general appearance of a housing development that emphasis is placed on the careful design of gardens and public open spaces. Every attempt should be made to reduce the visual intrusion of roads in a housing environment by the judicious use of hard and soft landscape treatments while ensuring that security is not compromised.



Maintaining existing trees that are in good condition and of value is well understood to accentuate the value of a new development.

Reference to the Scottish Government's [Green Infrastructure: Design and Placemaking](#) .

[Trees in Hard Landscapes: A Guide for Delivery](#) 

[Trees in the Townscape: A Guide for Decision Makers](#) 

(b) Function of Planting

A clear planting concept is required which satisfies the relevant functional and aesthetic objectives and helps form a relationship between the road and the surrounding environment. For example, planting may be employed to provide:

- ◊ *absorption of pollution and carbon capture;*
- ◊ *screening;*
- ◊ *reduce impact of noise;*
- ◊ *direct pedestrians;*
- ◊ *create vistas or focal points;*
- ◊ *act as a barrier;*
- ◊ *create shade;*
- ◊ *provide seasonal colour.*



The style of planting should suit the context of the road; for example, an urban environment will often demand more formal, geometric planting design whereas in rural areas naturalist planting and informal treatments can be more appropriate. Simplicity is often the best approach; a correct choice can create maximum impact while minimising initial and maintenance costs.

(c) Maintenance Consideration

Landscape design should seek to provide an attractive environment. In a planted area to be offered for adoption, consideration must not only be given to the function but also to the maintenance requirements. Management and maintenance problems can be largely avoided by appropriate design and proper consideration from the initial stages of the design process. The role of the Local Authority with regard to maintenance of planting is discussed in section 2.3.

(d) Other Landscape Features

Other landscape elements such as lighting, signs, barriers, walls and bridges should be considered within the overall design of the scheme and seen as opportunities to give a sense of place. Colour, scale and style all require careful consideration to ensure that these elements reflect an appropriate character. Boundary treatments are especially important; appropriate wall and fencing techniques should be used to create enclosure and properly define land in private or public ownership.

3.1.9 Additional Considerations

(a) Traffic Management

The layout of a development may be influenced by existing or proposed traffic management measures and the Local Roads Authority should be consulted about these at an early stage. Where the Local Roads Authority decides that traffic management measures should be introduced to facilitate a particular development, the developer may be required to reimburse the Authority for expenses incurred in the promotion and implementation of these measures. Note, that due to the process, the successful promotion of a Traffic Regulation Order is not guaranteed.

(b) Traffic Noise

The developer should consult with the Local Planning Authority to determine their requirements for dealing with external noise. Traffic noise from the following sources should be taken into account:

- (a) existing roads;
- (b) new roads being constructed as part of the proposed development;
- (c) alterations to the road network to accommodate the proposed development;
- (d) Road Authority's alterations to the road network for construction within a period of five years and/or included in the Structure Plan.

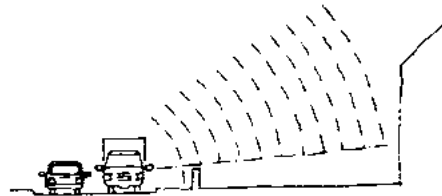

Figure 27 Traffic Noise

(c) Grit Bins

In all residential developments, and especially where pedestrian or vehicular routes have maximum permissible gradients, it will be necessary for the developer to provide either a widened portion of footway or an area of hardstanding to facilitate the placing of grit bins and to provide grit bins where required by the Local Roads Authority.





The provision and location of grit bins can be contrary to placemaking impacts and requires to be considered in context with function and place and should be considered as a part of the quality audit. Access for winter maintenance vehicles to maintain winter supplies must be considered in context also.

(d) Fire Fighting

Notwithstanding the recommended road widths in these guidelines, all roads should accommodate access and operation of fire tenders. The width of roads and reinforced emergency vehicle paths and their proximity to buildings is detailed in Part E of the Building Standards (Scotland) Regulations. This document specifies **a minimum width of 3.7 metres adjacent to low rise dwellings** to facilitate the use of pumping appliances (this width is increased to 4.5 metres to permit the use of heavy rescue and fire fighting equipment where buildings are 9 metres or more in height). **It should be noted that a basic vehicle path of 3.5 metres width (2.75 metres at pinch points) is appropriate for access but not operation of the fire tender.** Refer to [Designing Streets](#) .

3.2 Transport Assessment

A Transport Assessment (TA) will be required to be submitted to the Local Roads Authority (LRA) for all developments which have transportation implications. Developers must refer to the guidance contained within the current edition of the Scottish Government publication [Transport Assessment Guidance](#) . All developers must initially contact their Local Roads or Planning Authority to determine whether within any current local plan, the need for a Transport Assessment has been identified. The Transport Assessment Form in the Scottish Government publication [Transport Assessment Guidance](#)  **must** be submitted to the Local Roads Authority for all developments regardless of size. If the thresholds in the Scottish Government publication [Transport Assessment Guidance](#)  Table 3.1 are exceeded then a Transport Assessment must be submitted.

Following receipt of the Transport Assessment Form:

- (a) *Where threshold levels are met or exceeded, the Local Roads Authority will determine the extent and scale of any Transport Statement/Transport Assessment required, the details of which must be agreed by submission of a Scoping letter by the developer to the Local Roads Authority.*
- (b) *Where threshold levels are not met, a Transport Statement/Transport Assessment may still be required by the Local Roads Authority depending on the traffic sensitivity and transport implications of the development site.*

Further information can be obtained by reference to the Scottish Government website using this link .

A TA should examine the potential impact of a development on the surrounding transport network. This includes all transport modes such as walking, cycling, public transport and the private car. It should demonstrate that the site is a sustainable site in terms of transport usage and that private car usage can be minimised. A TA should include the following:

- ◊ a description of the proposed development, including plans showing the site location and site layout;
- ◊ a description of the current and existing transport network in the area that should include current footways and cycle routes (both off-road and on road);
- ◊ a description of the current public transport provision in the area. Current guidance states that the development should be no more than 400 m (a 5 minute walk away) from a bus stop. It is important that the most accurate information is provided and public transport information can be found on the Council's Public Transport bus timetable web pages;
- ◊ a forecast of the likely vehicle trip generation figures for the year of opening of the proposed development. This is normally provided by using the industry standard **TRICS** [trip generation database](#). It is imperative that the current version is used and that all outputs are included as an appendix in the final report and all assumptions made are clearly stated in the report.

Committed development in the vicinity of the development should be included within the report.

Full traffic counts and junction analysis for all junctions 'in scope' of the development. Junctions in scope are usually those within the vicinity of the proposed development or those which will be impacted by traffic travelling to and from the proposed development. Junction analysis can be carried out by using several industry standard packages such as **ARCADY**, **OSCADY** and **PICCADY** [link](#).

A Travel Plan (or Travel Plan Framework) showing what measures will be taken to reduce the dependence on the private car for trips made to and from the development.

The first step would be to appoint a firm of transport consultants to carry out the assessment. Most transport planning consultancies are able to fulfil this task and applicants should therefore obtain a number of quotations before deciding on which firm should undertake the work. The consultants should produce a 'scoping report' stating the methodology that they propose to adopt in carrying out the full assessment. This must be agreed by the Council before they can proceed to undertaking the full report. It is strongly recommended that the consultants actively engage in discussions with Council officers at the outset to agree the parameters for the study.

A full study should then be prepared and this should be agreed with the Council. The final report should be submitted as part of the planning application in order for the application to be determined fully by planning officers of the Council.

References

- ◊ *Transport Assessment Guidance 2012* [link](#)
- ◊ *Scottish Planning Policy (SPP) 2014* [link](#)
- ◊ *Planning Advice Note PAN 75 (Planning for transport)* [link](#)

3.3 Quality Audit

Auditing Quality Using Designing Streets

Designing Streets [🔗](#) is a policy document that contains guidance on getting street design right - so it should be the central reference when checking the quality of proposals for new streets within all urban and rural boundaries in Scotland. Checking quality should be a clear consistent method to reach collaborative agreement on how a proposal complies with **Designing Streets** [🔗](#). This page(s) and the associated Quality Audit Summary Report explain what should be done and how



Why?

Quality Auditing (QA), as noted on page 58 of **Designing Streets** [🔗](#), can simply be a sequence of checks to inform the design process and provide opportunities for developers to explain their reasoning. Any process that notes observations and records the decision-making process should help to deliver and maintain high quality places, for the benefit of all end users. QA joins-up assessment so one aspect of design doesn't dominate. A barrier to previous QA approaches has been a perceived duplication of work, so this method uses to the key considerations of **Designing Streets** [🔗](#), as used also in SCOTS guidance to avoid repetition. It should assist in a streamlined process of aligned consents:

Part 3

ROADS DEVELOPMENT GUIDE

Previous approach with multiple audits	v	New approach to auditing quality based on Designing Streets  Building Blocks	
Non-motorised User/Walking Audit and Cycle Audit/Review Accessibility and Equality Audit	v	A Single Quality Audit Against Designing Streets	Pedestrians and Cyclists
Functionality Audit	v		Block structure, public transport, junction types and arrangements, service and emergency vehicles, connections within a place
Visual Quality & Amenity Audit, Street Lighting Audit, Street Character Review	v		Context and Character, streets for people, reducing clutter
Parking Review	v		Integrated parking
Drainage Report	v		Drainage, utilities
Maintenance Audit	v		Materials, planting
Road Safety Audit	v		Achieving appropriate traffic speed
Traffic Generation Report Community Use Audit	v		Connections to wider networks, walkable neighbourhoods, orientation

10+ audits	v	1 unifying audit
Which audit gets priority?	v	A balanced approach
Duplication and overlap	v	DS broken down to building blocks or design aspects
Planning/roads assessed separately	v	Planning/roads (layout) assessed in parallel
Overall 'place' gets missed	v	Streets contribute to places

Who?

Engineers make individual value judgements on appearance, functionality and safety. But, when quality checks are done collaboratively by a professional team, balanced decisions are verified. This QA process encourages the team to engage as positive 'placemakers', to become adept at contributing creatively to places, and not be restricted to applying one particular infrastructure standard. The QA should be produced by the developer's team and openly discussed with local authority officers during pre-application discussions. At key stages the planning case officer and local authority officers responsible for Roads Construction Consent (RCC) should keep a summary on file, have access to an audit trail and any subsequent adoption agreement.

When?

Reviewing proposals to ensure that broad objectives are achieved cannot be solely undertaken at the finished scheme stage so QA should be an iterative part of the design, construction and stewardship process, particularly beneficial in the following circumstances:

- ◊ option testing stage;
- ◊ pre-application stage, then updated for planning and RCC applications;
- ◊ where strong tensions exist between different objectives;
- ◊ for schemes within existing streets, providing an opportunity for decision-makers to make a balanced assessment before approving a particular improvement solution; or,
- ◊ to explain thinking on street design aspects such as accessibility that can feed into a Design Statement, or Design and Access Statement, if one is required.

A summary report could be updated a few times but should at least be submitted along with a RCC application that should align with the planning application. The same information will sum up the layout of roads/streets and public spaces.

How?

1 Briefing

The project brief setting out the vision of development is possibly the most important reference for any project so QA begins by checking against design objectives set at this early stage. All project briefs for works that impact on the design of street should define clear objectives related to the 6 Qualities of Successful Places as defined in Scottish Planning Policy (SPP).

2 Design Stages

As a project's design evolves, assessing the quality of street design depends on breaking the 6 qualities down into **Designing Streets** [18](#) 'key considerations' or aspects of design:

Block structure	Pedestrians and cyclists	Connections within a place	Walkable neighbourhoods	Connections to wider networks	Orientation
Context and character	Achieving appropriate traffic speed	Public transport	Streets for people	Integrated parking	Drainage
	Reducing clutter	Junction types and arrangements		Service & emergency vehicles	Utilities
					Planting
					Materials

Considering all aspects together puts *place before movement*, with streets designed to facilitate quality of life rather than only be only transport corridors.

The following steps describe how to complete the **Quality Audit Summary Report** template that follows, designed to concisely record a snapshot:

- Step A** *Reference the brief and an annotated plan, a ‘B-Plan’ colour-coded analysis (see page 21 of [Designing Streets](#)) to help identify and precisely locate specific design issues that the QA deals with.*
- Step B** *Summarise and record an assessment of each aspect of design (ordered in the hierarchy of street structure, street layout and street detail) to form a decision-making trail.*
- Step C** *Summarise or link to additional audits (that form part of an overall balanced view, with no superior status) such as:
 - A Road Safety Audit**, if required, to build on achieving appropriate traffic speed. Agree the scope at the initial stages, identify potential safety problems and assess possible actions to reduce risk. Included summaries of balanced decisions to mitigate residual conflicts (ref: [HD 19/15](#)).
 - A Transport Assessment**, if required, will appraise the operational implications of development then look at mitigations such as physical changes to existing connected networks, or travel plans (ref: [Transport Assessment Guidance](#)).
 - An Equalities Audit**, with due regard to the [Equalities Act 2010](#), will appraise desire lines together with material colours adopted in the design.Other Audits, depending on the scale and nature of a project, considered in more depth, for example: security or lighting of public spaces. Some aspects such as drainage or materials specification may be agreed in principal at planning then supplemented later. Any specific report that significantly affects overall quality, can be linked or appended.*
- Step D** *End with a judgement, reached via multidisciplinary collaboration (on the overall quality of street design). This judgement should be supported with a risk assessment (severity/likelihood of occurring) appended (see [HSE Risk Assessment](#)) which addresses all the audit/report findings into a final balanced conclusion report.*

3 Construction

As completion nears a QA review should ensure recommendations have been taken on-board and objectives delivered. Consideration of the findings of a post-completion RSA (stage 3), if applicable, can be taken into account.

4 Maintenance and Monitoring

During the maintenance period a review should establish if the objectives and any expected changes in road user behaviour have been achieved. This could include the conclusions of a stage 4 RSA.

5 Quality Audit Summary Report

This QA report template should be used to summarise the process undergone as part of the design and implementation of a new road or street project.

It should demonstrate what consideration has been given to all the key areas outlined in **Designing Streets** [🔗](#) and should provide an audit trail of the decision making process where a compromise or departure from normal standards has been opted for.

[Quality Audit Summary Report Template](#) [🔗](#)

3.4 Construction Design

3.4.1 Geotechnical Considerations

(a) Introduction

The extent and type of ground investigation requirements with detailed reporting will be dictated by the nature of the proposed development, former land use and local ground conditions.

The Interpretative Report which must be submitted with the application for Construction Consent will be examined against the engineering drawings submitted and the supporting factual information.

(b) Supporting Technical Documentation

All ground investigation reports should comply with BS 5930: 1999 Code of Practice for Site Investigation. The Factual Ground Investigation Report should include the following minimum information:

- (a) *exploratory hole logs to BS 5930: 1999;*
- (b) *laboratory test data to BS 5930: 1999 and BS 1377: 1990 relevant to the proposed form of road construction;*
- (c) *a location plan of the site at 1/2500 scale with the proposed road superimposed;*
- (d) *a plan at 1/500 scale showing the co-ordinated location of all exploratory holes and the proposed road.*



The spacing between and the nature of the depth of exploratory holes is dependent upon the ground conditions and nature of development (Figure 28). Typically, exploratory holes should be sunk at a maximum spacing of 25 metres offset from the centreline of the proposed road where necessary to ensure sufficient transverse coverage along the site. Where changing conditions demand clarification closer spacing may be necessary.

Where it is proposed to locate a road over land previously used for industrial purposes or waste disposal, it is essential that chemical analysis and gas monitoring information is submitted in addition to standard laboratory testing to BS 5930: 1999 and BS 1377: 1990.

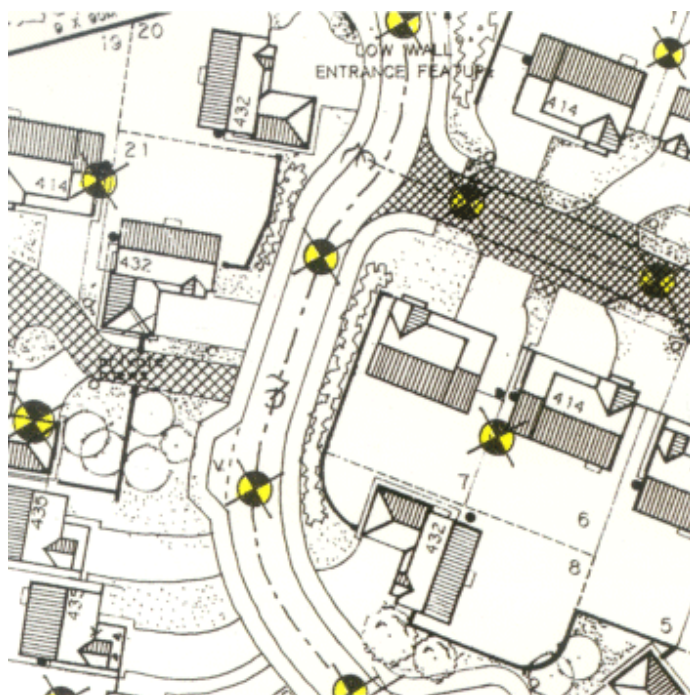

Figure 28
Exploratory Borehole Survey

(c) Interpretative Report

The Interpretative Report must include a Mineral Report specifically dealing with the implication for the proposed road construction.

(d) Brownfield Sites

Where a site has formerly been developed it will likely be covered in fill material, ie a brownfield site. The nature, depth and extent of this material should be defined. The possibility of the ground being contaminated must be considered. The Interpretative Report should assess any contamination and its implications for both road construction and maintenance of the completed road and its drainage system.

(e) Peat

Where a proposed development road is to be constructed over peat or buried peat, it will be necessary to excavate and replace the peat in virtually all cases.

(f) Geotextiles/Polymer Grids

Geotextiles or polymer geogrids may be used as a construction expedient to assist construction; however they cannot prevent consolidation settlement or secondary compression in soft compressible soils.

Geotextiles or polymer geogrids may not be used as a substitute for a capping layer or as a means of reducing sub-base thickness in normal road construction. They may be used in addition to a capping layer or normal pavement construction to resolve a particular problem. The decision to use geotextiles or polymer geogrids must consider the need for long-term integrity, damage from road openings and the practicality of effective repairs to the geotextile/geogrid. Developer to provide a manufacturer quality check of geotextiles/polymer grid.

(g) CBR

The CBR value of the soil shall be determined by the laboratory CBR test in accordance with BS 1377: Part 4: 1990 and test data shall be incorporated in the Factual Ground Investigation Report.

3.4.2 Specifications

The specification for the construction of road pavements and associated structures is detailed in the following link: [DMRB HD 26/06](#) . Clause and Appendix numbers in the following text refer to that specification.

3.4.3 Subgrade Drainage

In addition to the requirement for surface water drainage, it is important to provide efficient permanent drainage of the subgrade and any other permeable layers of the Road.

Where Roads have no frontage development, subgrade drainage will be effected as follows:

- (a) *In cuttings, filter drains which will be required to cater for surface water run off from slopes will also provide a sub grade drainage function by being located deep enough to prevent the water table from rising to within 0.6 metre of the formation level.*
- (b) *In embankments, capping layers and/or sub-base layers must be extended periodically to the face of the embankment to effect drainage of these layers.*

Where roads do have frontage development and adjacent ground levels do not involve embankments or cuttings, it is unlikely that specific measure will be required to effect drainage

of the permeable layer unless the site investigation indicated that either the water table is likely to rise to within 0.6 metres of formation level or that the material below formation level is highly impermeable.

In either of these cases, sub-grade drainage can be effected by ensuring that backfill material to gully connections is permeable and that water which will accumulate in this backfill is provided with an outlet which, while allowing water to permeate into manholes, ensures that bedding and backfill materials of the drain are retained.

3.4.4 Carriageway Construction

(a) Pavements

Carriageway Pavement design should be in accordance with Section 2: Volume 7 of the **DMRB HD 26/06** [🔗](#). This requires details of the ground bearing capacity and the traffic type and volumes to be identified to arrive at a suitable load spreading pavement. A composite construction may be acceptable providing agreement with the road authority is sought in advance.

BS 7533 [🔗](#) for block paving and the additional qualifications and exceptions listed here.

Capping Layer

Where the CBR value is less or equal to 5%, a capping layer is required as per Figure 29.

NB: The design California Bearing Ratio (CBR) should be obtained either by testing or by measurement of the plasticity index of the subgrade material. In the case of CBR testing, the method described in the laboratory test in accordance with BS 1377-4:1990, clause 7 should be used and is only relevant in natural soils and cannot be used for pavement design in fill materials. By their nature fills are random and highly variable in density and CBR testing in them only assesses the quality of the material at the locus of the test. Therefore for pavement construction on fill materials, unless the fill material is equivalent to or better than the specified capping material, a full capping layer is required.

Frost Susceptibility

It is possible for roads designed to have a total bituminous thickness of 170 mm and, with a CBR value < or + to 2%, a 150 mm sub-base and 600 capping layer. In such circumstances

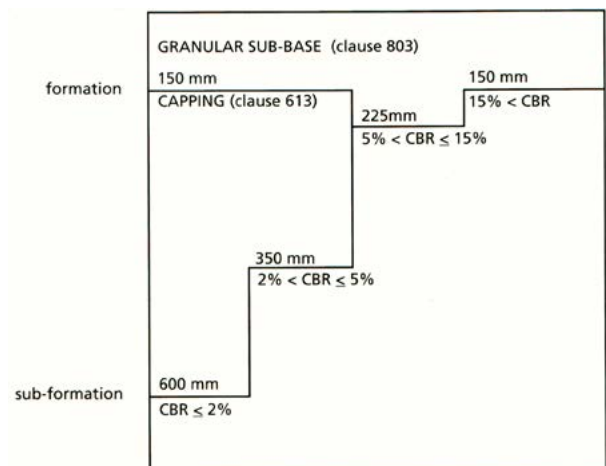

Figure 29 Capping Layer Requirements: subject to frost susceptibility

the upper 130 mm of the capping layer should be non frost-susceptible. In practical terms this effectively means that the sub-base becomes 280 mm with a capping layer of 470 mm. For a $2\% < \text{CBR} < \text{or} +5\%$ where the total bituminous thickness and sub-base thickness together are less than 450 mm the same principle applies (ie the sub-base is increased to achieve 450 mm of non frost susceptible material and the capping layer can be correspondingly reduced). This need not be done if the capping layer is non frost-susceptible.

Increased Capping Layer Thickness

Although Table 10.1 gives various thicknesses of capping layer dependent upon CBR, where CBR is significantly below 2%, these thicknesses may require to be increased dependent upon site and weather conditions prevailing at the time of construction. This requirement will be accompanied by an additional CC8 Engineers report to certify the design. Additional material may require to be removed and replaced by more suitable material. Although the new material may be of good quality, the subgrade shall be assumed to be equivalent to one of a CBR just under 2% and requiring 600 mm of capping layer. The developer should consult the Local Roads Authority for advice in these circumstances.

Formation on Rock

Where the formation is on rock, the granular sub-base will act as a 150 mm depth regulating layer.

Carriageway Construction

Where suitable technical facilities exist it is recommended that the specific circumstances of each site are catered for by designing the road in accordance with the criteria stipulated above, subject to a minimum construction as required to carry 0.5 Million Standard Axles (MSA), for all roads. In this circumstance it will be necessary to complete and return form CC8 'Carriageway Design Certificate' (see Appendices).



(b) The Use of Secondary or Recycled Materials

The use of recycled materials in carriageway and footway construction will comply with **HD 35/04 Part 2: Section 1; Volume 7 of the DMRB**. Developer to provide test certificates and details of source of supply for secondary or recycled materials.

Based upon the **Specification for Highway Works (SHW)** [MCHW Volume 1] and **HD 35/04 Part 2: Section 1; Volume 7 of the DMRB** and advice from **WRAP** reclaimed asphalt can be used in:

- Bitumen bound materials - base, binder and surface courses (up to 10% by mass reclaimed asphalt may be used in surface courses and up to 50% in all other layers). Asphalt can be recycled back into hot asphalt, a process which gains the benefit from the original bitumen and high quality aggregate; or into cold lay foamed bitumen, which is growing in popularity.

- ◊ Concrete - can contain up to 5% asphalt as a foreign material, but reclaimed asphalt is generally not viewed as a concreting aggregate.
- ◊ Pipe bedding - Recycled asphalt should not be used in pipe bedding or drainage applications.
- ◊ Hydraulically bound mixtures (HBM) for sub-base and base - up to 100% reclaimed asphalt.
- ◊ Unbound mixtures for sub-base - Series 800 permits up to 50% reclaimed asphalt in types 1 and 2 and 100% in type 4.
- ◊ Capping - 100% reclaimed asphalt can be used in this layer.
- ◊ Embankments and Fill - where permitted, up to 100% reclaimed asphalt may be used. Reclaimed asphalt is not permitted as backfill to structures.

Asphalt containing tar or tar bitumen is generally not appropriate for recycling **WRAP** .

(c) Two Stage Construction

Where, owing to the continued use of the road by construction traffic, it is necessary (in order to avoid damage to the surface course) to adopt a two stage construction. The pavement design is required to confirm the load spread pavement capacity over the period of the construction such that the foundation and base is not overstressed, thereby ensuring the initial whole life design period.

Stage One

The first stage for both bituminous and block paved road, shall be the top of the specified bituminous base. Consideration should be given to the temporary drainage of the first stage, to minimise ponding caused by the projection of gully gratings, above the temporary surface, either by adjustment of gully frames or other approved method. This applies particularly in large projects where the construction period may be long and the surfacing course not laid before a winter work period. Any settlement which may occur in the base of bituminous roads shall be made up with regulating course before the laying of the surfacing course, and early reinstatement of openings or failed areas is essential.

Stage Two

Before the binder and surface course - where it is bituminous - is laid, the top surface of the base must be well cleaned and a tack coat applied at the rate of 0.6 litres per square metre. In the case of block paved roads the bituminous base material must be adequately maintained during the first stage and any openings or failed areas reinstated as soon as possible to ensure that the bedding layer thickness is regular and within tolerance.

Design Depth Minimum Requirements

The following criteria, which must be used in designs for specific circumstances:

- (i) design life - 40 years;
- (ii) traffic growth rate - 4%.

Based on the above, the construction specified caters for the following traffic:

- *Main Road or Industrial Access Road - up to 75 commercial vehicles per day on day of opening.*
- *Residential Main Road - up to 40 commercial vehicles per day on day of opening.*
- *Housing Road and Pedestrian/Vehicular shared surfaces or Minor Commercial Access - up to 15 commercial vehicles per day on day of opening.*

In specific circumstances which would permit future overlay in order to extend the pavement life to 40 years (eg where there is no frontage development and the number of commercial vehicles exceeds 100 per day), the design life can be restricted to 20 years, with the agreement of the Local Roads Authority.

(d) Clay, Natural Stone or Block Paving Pavements

All pavements being constructed with Clay, natural stone or Block Paving will be in compliance with BS 7533.

Light colours of blockwork are not appropriate where there is a risk of staining from diesel or oil spillage.

3.4.5 Street Transitions Methods

Direct reference to be made to 'Streets for People' section of [Designing Streets](#) and [TRL 661](#).

Vertical Displacements

Definition

A vertical displacement may be defined as a vertical change to the carriageway which, in residential areas, takes the form of a flat top platform or transition to a shared surface.

Dimensions

Flat top platforms at Raised Junctions in new developments should have a 2.5 metres ramp length and should extend across the whole junction.

Figure 30 details vertical displacement construction. Surface material for Raised Junctions may be asphalt, blockwork or preformed elements laid in accordance with Figure 30 on page 122.

Road Markings

All vertical measures should be highlighted to identify their presence which can be achieved by a change in colour or texture. Where the Local Roads Authority has advised that a 20 mph zone will not be introduced then vertical measures require to be marked in accordance with [The Traffic Signs Regulations and General Directions 2002](#) (and as amended).

Part 3

ROADS DEVELOPMENT GUIDE

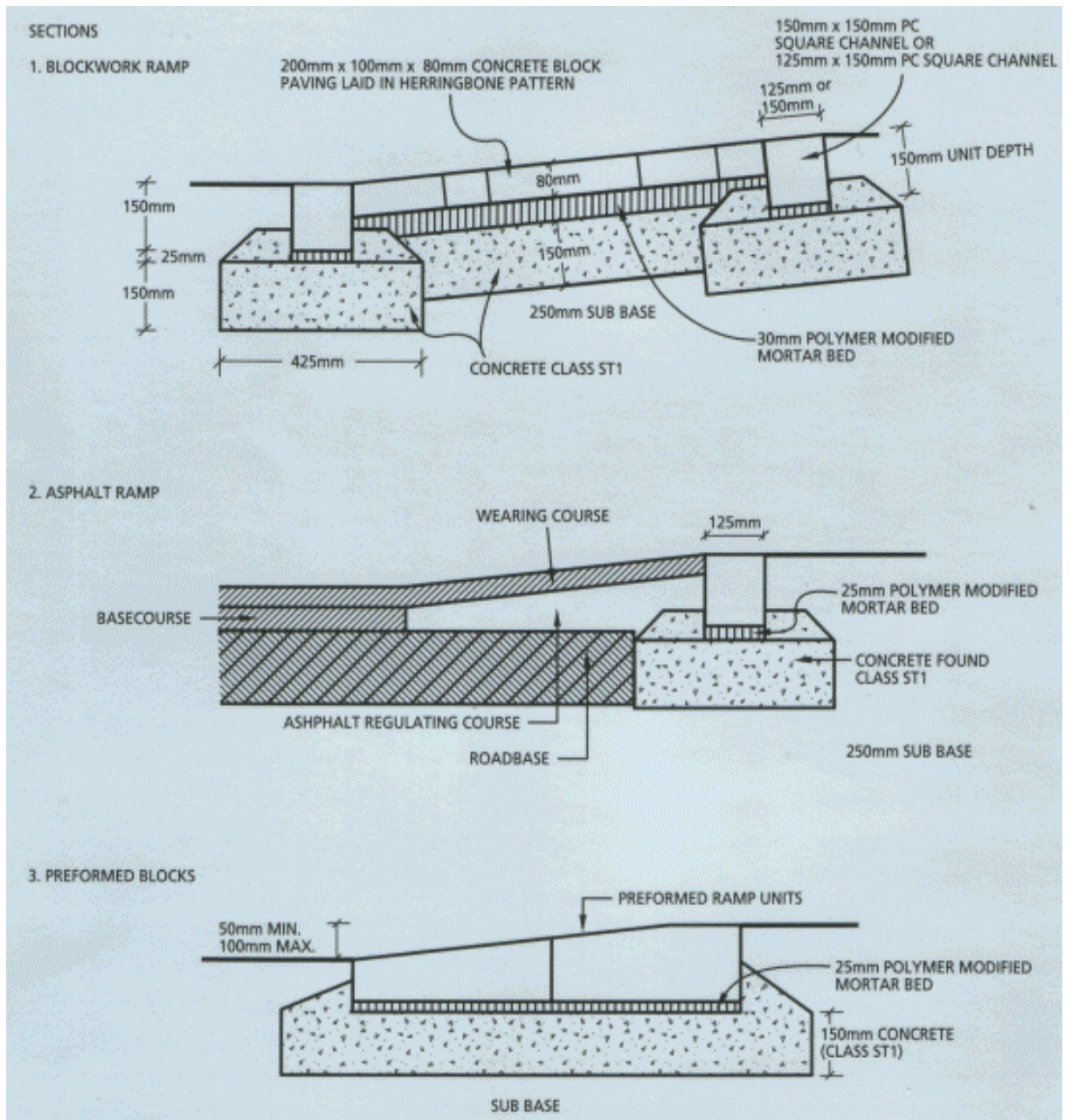

Figure 30 Vertical Displacement Ramp

3.4.6 Footway, Footpath and Cycle Track Construction

Construction Material

Footways, footpaths and cycle tracks pavement design should be in accordance with **Section 2: Volume 7 of the DMRB** [↗](#) unless an alternative design is agreed with the Local Roads Authority



3.4.7 Kerbs and Edging

(a) Materials/Construction

All carriageways, footways and footpaths should be provided with precast concrete kerb or edging. Alternatively and with the agreement of the Local Roads Authority natural stone kerbs may be acceptable.

On conventional roads, kerbs should be set 125 mm above finished carriageway channel level, except at pedestrian and vehicular crossings where this dimension is reduced, pedestrian crossings range from 0 mm to 10 mm and vehicle access range from 25 to 40 mm. Edging at the heel of footways and footpaths should be set flush with the walking surface.

On shared surfaces an upstand of 40 mm should normally be provided except at junctions with footpaths and private accesses where kerbs should be flush with the walking surface. Approval for any departure from, or clarification of, these standard details should be sought from the Local Roads Authority prior to construction commencing.

(b) Remote Areas

In remote areas, and with the agreement of the Local Roads Authority, cycleways may be constructed without kerb edgings, where the sub-base is laid 500 mm wider than the surfacing to provide shoulders.

3.4.8 Accesses

(a) Driveways

Vehicular access crossings of the footway for individual dwellings should comply with Figure 31 and be constructed to the footway specification. Maintenance difficulties preclude the use of slab footway construction for vehicle access crossings. Precast concrete is more durable.



Figure 31

(b) Other Access Details

Where vehicular access, other than to individual dwellings, is taken over a footway, a crossing, as detailed in section 3.1.2 should be constructed. If the crossing is being built in isolation from other roadworks it is recommended that the specification be agreed with the Local Roads Authority. Rigid construction may be acceptable but reinforcement may be required where the use of heavy vehicles is expected.

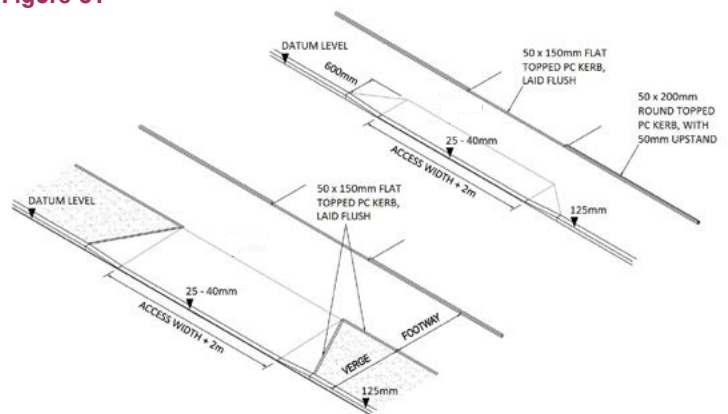

(c) Pedestrian Access/Crossings

Reference should be made to [Designing Streets](#) : Street Structure where crossing locations are discussed.

Figure 32 details the requirement for dropped kerbs where pedestrian routes cross the carriageway from adjacent footways, eg at T-junctions and pelican crossings. Pedestrian crossings of a carriageway with an adjacent grass verge should comply with Figure 31 except that the dropped kerb should be set flush, or not more than 6mm upstand, with the carriageway and extend for a minimum length of 1.8 metres.

Tactile Paving Surfaces

Reference to Department for Transport's publication **Guidance on the Use of Tactile Paving Surfaces** [↗](#) should be sought for formal crossing points however this must be read with further advice from **Designing Streets** [↗](#) regards some layouts.

Figure 32 Dropped Kerb Detail at Designated Pedestrian Crossing

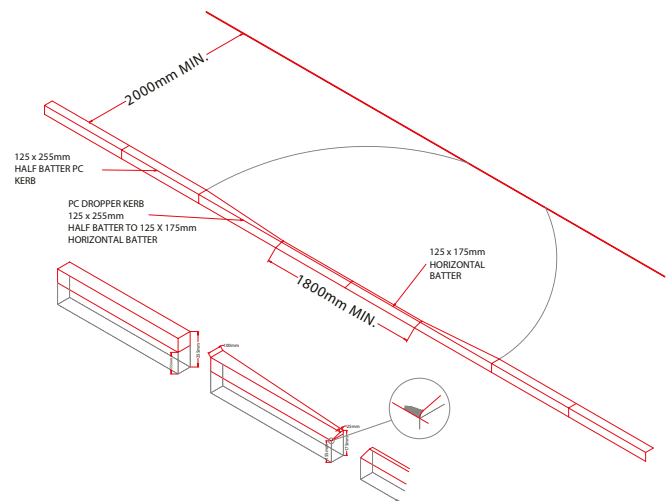

3.4.9 Road Drainage and SUDS

(a) Specification Best Management Practices

The specification for the construction of road drainage shall be the [Specification for Highway Works \(SHW\)](#). Volume 1 of the Manual of Contract Documents for Highway Works. In addition, road drainage should meet with the requirements of Scottish Water and the [Scottish Environmental Protection Agency \(SEPA\)](#).

Design

Road drainage design should be in accordance with the current edition of Sewers for Scotland as regards hydraulic design subject to the qualification that the minimum pipe diameter permitted will be 150mm and the Design Manual for Roads and Bridges as regards pipe strength and bedding for main road loading for pipes in or adjacent to carriageways. Land drainage or other appropriate measures must be taken to prevent water flowing on to the road from adjacent properties.

The road drainage must take full account of sustainable urban drainage systems and use 'Best Management Practice' structures and techniques in dealing with discharges to existing watercourses or public sewers.

Sustainable Urban Drainage Systems

Advice on the design concepts are contained in [SUDS for Roads](#), [Ciria C753 The SUDS Manual](#) and [Ciria C635](#). The final design of the drainage system must be to the satisfaction and meet the requirements of the local Roads Authority, the appropriate [Water Authority](#) and [Scottish Environmental Protection Agency \(SEPA\)](#).

(b) Gully Spacing

Table 10 details the acceptable channel distance between gullies for a road comprising carriageway with two number 2 metres wide footways, based on criteria adapted from [TRRL Report LR 277](#). (Table 10 is based on rainfall intensity of 50mm/hour and width of channel flow of 600mm). The spacing may require to be altered according to the road layout (eg at junctions) and special measures will be required where the grade is necessarily flatter than 0.8 per cent (sags, crests, etc). Advice on these matters should be sought from the Local Roads Authority who should be consulted at an early stage by an developer wishing to carry out a full drainage design. Irrespective of design spacing's, a gully should be positioned:



- (a) just upstream of the tangent point at road junctions;
- (b) short of the point where adverse camber is removed when applying super-elevation;
- (c) at any local low point;
- (d) at speed control measures, where necessary.

They should not be positioned:

- (a) at pedestrian crossing points,
- (b) at driveways;
- (c) at extended channel line of parallel lay-by parking;
- (d) at channel line at bus bays.

Table 10 Gully Spacing for Carriageways

Gradient:		Flatter than	1/150*	1/100	1/80	1/60	1/40	1/30	1/20
		1/150 (0.66%)*	0.66%	1.00%	1.25%	1.66%	2.50%	3.33%	5.00%
Cross Section	C/Way Width		Gully Spacing (metres)						
1 in 40	5.5m	20	30	35	40	45	55	60	75
(2.5%)	6.0m	20	25	30	35	40	50	60	70
Camber	7.3m	15	20	25	30	35	40	45	55
1 in 40	5.5m	10	15	17	20	22	27	30	37
(2.5%)	6.0m	10	12	15	17	20	25	30	35
Crossfall	7.3m	7	10	12	15	17	20	22	27

* Gradients flatter than 0.8% are applicable to sags and crests only

(c) Irregular Areas

For large, irregularly shaped areas the empirically derived formula of one gully for each 100 square metres of catchment may be used. Additional gullies will be required where gradients are steeper than 1/20 or flatter than 1/150 and where surface water draining from adjacent areas may be anticipated.

Figure 33 Road Gullies

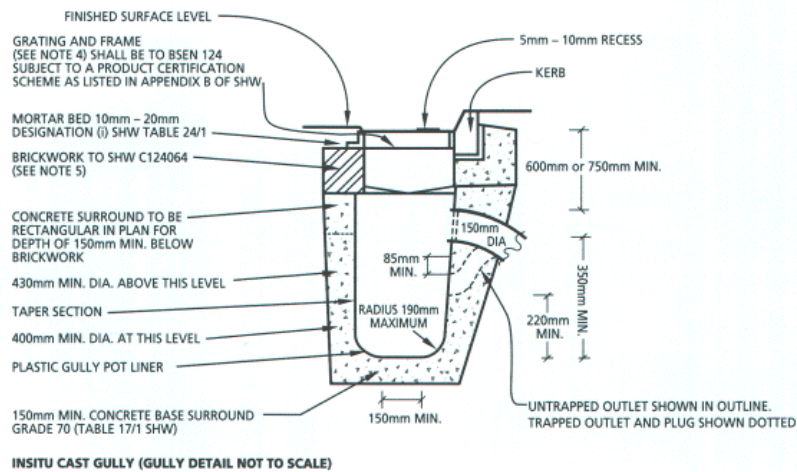
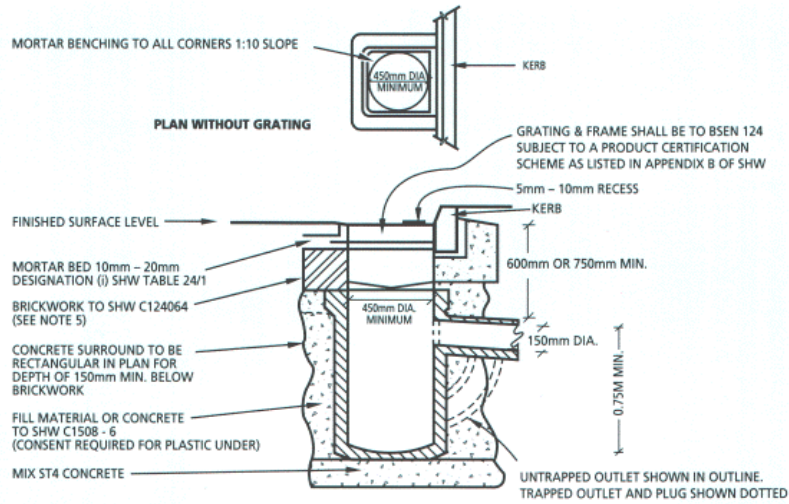

NOTES

1. THE MINIMUM DEPTH FROM THE TOP OF THE GRATING TO THE TOP OF THE GULLY OUTLET IS TO BE 750mm WHEN THE CONNECTING PIPE IS UNDER A CARRIAGEWAY OR A HARD SHOULDER AND 600mm ELSEWHERE.
2. PRECAST CONCRETE GULLIES SHALL BE TO BS 5911: PART 2.
3. WHEN AN INSITU CAST GULLY HAS A TRAP, THE STOPPERS SHALL COMPLY WITH REQUIREMENTS OF BS 5911: PART 2.
4. THE GULLY GRATING NORMALLY SHALL BE D400 OR C250 TYPE AS APPROPRIATE WITH MINIMUM FRAME DEPTH OF 100mm OR B125 FOR NON-CONTIGUOUS PARKS.
5. BRICKWORK SHALL BE FLAT BEDDED (MORTAR THICKNESS 10mm to 25mm) AND NOT TO BE TRAFFICKED UNTIL SPECIFIED STRENGTH (AS INDICATED IN THE CONTRACT DOCUMENT) IS ATTAINED.
6. THE BACK FACE OF THE GULLY POT SHALL BE IN A VERTICAL LINE WITH THE FRONT FACE OF THE KERB AND THIS WILL PRECLUDE CORBELLED BRICKWORK.
7. CORBELLING TO BRICKWORK IF NECESSARY, 25mm MAXIMUM.
8. LEVELLING BRICKWORK DEPTH SHALL BE A MULTIPLE OF 75mm.
9. WHERE INSITU CONCRETE GULLIES ARE FORMED WITH PERMANENT SHUTTERING SUCH SHUTTERING SHALL HAVE A CURRENT BRITISH BOARD OF AGREEMENT ROADS AND BRIDGES CERTIFICATE.
10. WHERE BOTH NON ROCK AND CAPTIVE HINGE GRATING IS REQUIRED, THEN TYPE D400 SINGLE PIECE, HINGED, NON ROCK WATERSHED OR SIMILAR APPROVED TYPE CAN BE USED.

Figure 34 Chamber Construction

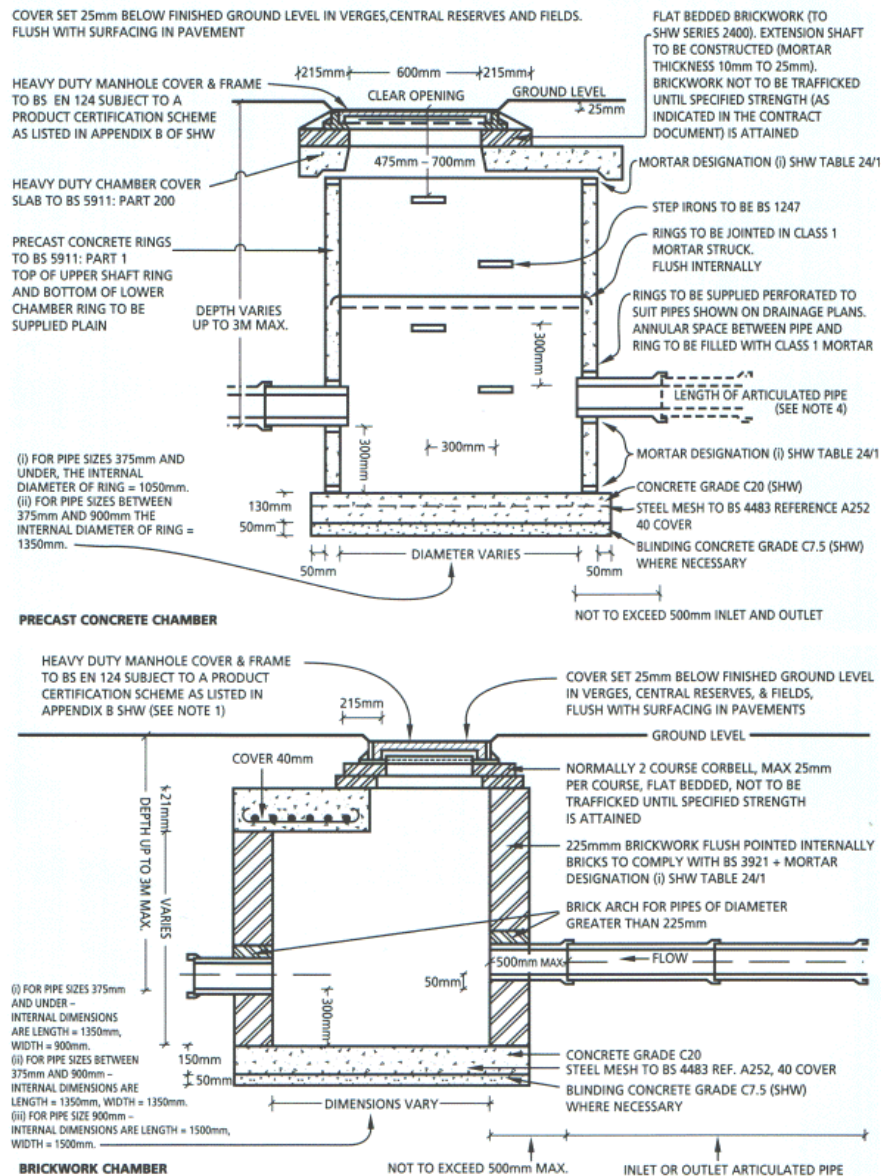

NOTES COMMON TO BOTH CHAMBER TYPES

1. MANHOLE COVER SHALL BE DOUBLE TRIANGULAR 600mm x 600mm SQUARE OPENING, MIN. FRAME DEPTH 100mm.
2. WHERE THE OUTLET PIPE IS GREATER THAN 450mm DIAMETER A SAFETY CHAIN (DRAWING AVAILABLE FROM THE NETWORK MANAGER) HAS TO BE PROVIDED ACROSS THE OUTLET FACE.
3. REFER TO THE SPECIFICATION FOR HIGHWAY WORKS (SHW) REGARDING BACKFILLING TO CHAMBER.
4. FOR LENGTH OF ARTICULATED PIPE REFER TO SHW TABLE 5/6.
5. THE BOTTOMMOST STEP SHOULD NOT BE MORE THAN 300mm FROM THE FLOOR.
6. WHERE CHAMBER IS LOCATED IN THE CARRIAGEWAY THE LEVEL OF THE TOP OF THE COVER SLAB SHALL BE BELOW THE TOP OF THE ROAD BASE LEVEL. EXTENSION SHAFT SHOULD NOT BE MORE THAN 300mm.

(d) Lay-by Drainage

Lay-bys should be drained by means of gullies located on the road channel line or rear of lay-by or other sustainable means clearly demonstrated and which does not encourage flows back onto the road.

(e) Footpath Drainage

Remote footpaths should be constructed with flush edging. Only in exceptional circumstances, and where there is appropriate access for gully cleaning vehicles as agreed with the Roads Asset Manager, should direct drainage into gullies be considered.

(f) Gullies

Road gullies should be trapped and constructed in accordance with clause 508 of the Specification. Gully gratings and frames must be positioned with grating bars not parallel to the kerb to facilitate cyclists and shall be of the captive variety. They shall comply with BS EN 124 and Class D400 in all adopted and adoptable areas, (minimum nominal width 450 mm, minimum area of waterway 900 cm² and minimum depth of frame 100 mm). The use of Class B125 (minimum nominal width 325 mm, minimum area of waterway 650 cm² and minimum depth of frame 100 mm) may be permissible in non contiguous car parks at the discretion of the Roads Authority.

(g) Connections

Connections should be constructed in accordance with clause 508 of the Specification. They must be formed with junction pipes unless the Local Roads Authority has specifically approved the use of saddles.

(h) Chambers

Chambers should be constructed in accordance with Clause 507 of the Specification. Manhole covers and frames shall be non rock and comply with BS EN 124 and be Class D400 (minimum clear opening 600 mm dia or equivalent, minimum depth of frame 100 mm) except in non contiguous car parks or verges where the use of Class B125 (minimum clear opening 600 mm dia or equivalent, minimum depth of frame 100 mm) will be permissible.

(i) Outfall Connection

The connection of road drainage systems to the public sewer network should be undertaken only on the authority and to the requirements of Scottish Water. Similarly, when connecting to an existing watercourse, approval should also be sought from the Local Authority Flood Risk Management team.

3.4.10 Landscape Treatment

Refer to Roads Authority landscaping departments for agreement on maintenance requirements and definition of standard planting in association with any SUDS system - refer to [Specification for Highway Works Series 3000 - Landscape and Ecology](#) [link](#).

(a) General Issues

Materials chosen should be appropriate in appearance and performance and should be used in a consistent manner according to the function of different areas. Local materials and styles should be used, avoiding over-elaborate detailing and pastiche. Inappropriate standard details should not be imported from an area with a different landscape character.

(b) Planting

Required Permission

Any planting carried out within the road or on land adjacent to the road will require to receive written permission from the Roads Department prior to the commencement of the planting. Landscape treatments should be designed for effective long-term maintenance and the highest standards of ground preparation are required to ensure successful establishment and the ongoing health of plants.

Appropriate Species Selection

Plant material comprises trees, shrubs, ground cover, climbers, bulbs and grass. Plant selection must take into account the following points as well as the desired design objectives:



- ◊ suitability for the site;
- ◊ hardiness and tolerance to pollution and road salts;
- ◊ commercial availability;
- ◊ initial and eventual size above and below ground;
- ◊ shape;
- ◊ colour and seasonal variation;
- ◊ growth rate;
- ◊ maintenance requirements;
- ◊ other traits such as over-searching roots, weak branches, attractiveness to aphids.

With all “native” or “naturalised” planting, advice on suitable species, mixes, densities and soil preparation can be sought from various sources such as local Landscape Professionals and Ecologists. Many areas of Scotland have appointed Area Ecologists. Ecological societies can also be a valuable source of information.

Siting Plants

Trees should be located to allow full branch spread as trees which are too close to the kerb may grow asymmetrically due to continuing contact with tall vehicles. This can be avoided by ensuring that all tree branches do not encroach within 450 mm of the kerblines up to a height of 5.3 metres. Tree planting proposals should also take full cognisance of the road lighting layout to ensure that no inappropriate shaded areas are created.

Protection of Services

Trees and shrubs should not be located where they are likely to cause damage to adjacent pavings, buildings, or services underground: refer to [NJUG Publications](#); where necessary protection should be provided. Care must also be taken in the siting of trees to make allowance for access to buildings by emergency vehicles and fire engine turntables.

Maintaining Visibility

Trees can be located on their own, in a group, or in lines which can be parallel to the carriageway or at an angle to the carriageway. They should not obscure visibility when planted or when mature. To ensure good visibility without having to rely on frequent maintenance, the growth potential of shrubs planted in verges should be under 600 mm in height.

Soft Verges

Soft verges should be grassed (see clause 618 in [Specification for Highway Works Series 3000 - Landscape and Ecology](#)) unless an alternative form of surfacing is authorised by the Local Roads Authority. There must be a permanent demarcation of the boundary between the verge and the adjoining private property (eg by concrete edge kerbing or boundary walls).

Topsoil

Topsoil is to comply with clause 618 and appendix 6/8 - see [Specification for Highway Works Series 3000 - Landscape and Ecology](#).

Grass Seed

Unless otherwise agreed by the Local Roads Authority, grass seed should comprise the mixture listed in Appendix 6/8 of *Specification for Highway Works Series 3000 - Landscape and Ecology*. The developer will be responsible for resowing, in the following season, any area where the seeding is not successful for carrying out all requirements of clause 618 of *Specification for Highway Works Series 3000 - Landscape and Ecology* until the road is adopted.

Hard Verges

The form of any hard landscaping should be agreed with the Local Roads Authority at an early stage of the design process. Where hard verges are provided on Traffic Distributor Roads, they should be surfaced with pedestrian deterrent paving.

Statutory Undertakers' Requirements

The restrictions which can be enforced on planting by Statutory Undertakers' services have to be identified at an early stage and the appropriate selection and modifications made as necessary: *NJUG Publications*.

Root Containment

Whenever possible trees should be planted in free draining, uncontained tree pits as this creates the best environment for establishment and the ongoing health of the tree. However, it is acknowledged that in certain locations it may be necessary to restrict root growth through containing the root zone. In such cases, it is vital that the container provide an adequate volume for root growth; 3 m³ is considered acceptable. It may be noted however, that root growth is rarely symmetrical and an irregular shape of container can still provide healthy growing conditions. Typical details for growing trees with or without containment and showing the implications for tree anchorage are shown in Figures 35 and 36.

Tree Protection

In urban locations, where new trees are likely to be vulnerable to vandalism or impact from vehicles, tree guards should be employed to provide a measure of protection.

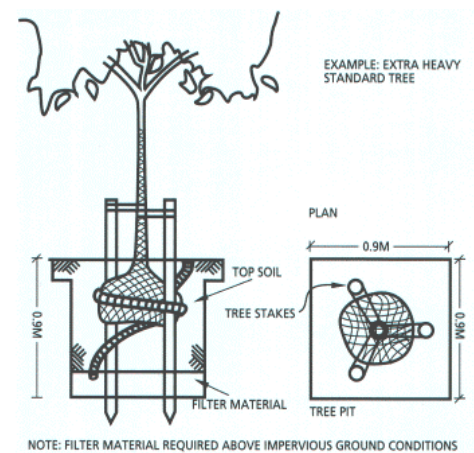

Figure 35 Tree Planting Detail Without Containment

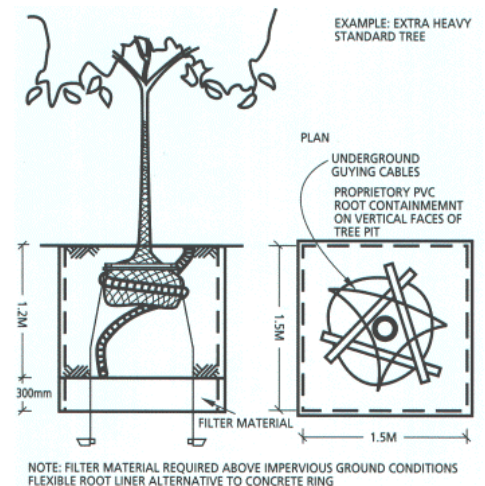

Figure 36 Tree Planting Detail With Containment

3.4.11 Lighting Design

(a) Compliance

Lighting shall generally be in accordance with the European and British Standards **BS EN 13201 Road Lighting** [↗](#) and **BS 5489 Code of Practice for the Design of Road Lighting in 2003** [↗](#).

BS 5489-1 2013 contains guidance and recommendations to support BS EN 13201 and to enable designers of road lighting schemes to comply with it.

(b) Connection to Existing Apparatus

Where the road lighting in a development is to be connected electrically to any existing Roads Authority lighting column or feeder pillar, the Local Roads Authority's representative will, on receipt of Construction Details and Visual Inspection Certificate DCC2 carry out the necessary connection or connections at the point of supply in accordance with the **Electricity at Work Regulations 1989** [↗](#), the cost to be borne by the developer. The Local Roads Authority representative will require a minimum of 5 working days notice (excluding weekends) from receipt of the Construction Details and Visual Inspection Certificate DCC2 to provide the connection facility. Alterations to existing services and equipment which the Local Roads Authority deems necessary to accommodate the development will be charged to the developer on a time and material basis. The Local Roads Authority's representative should be afforded the opportunity to witness the tests, and may disconnect the installation from the Roads Authority's supply network in the event of the test results proving unsatisfactory. Test results must be recorded on Electrical Inspection Test Certificate DCC3 and be submitted to the Local Roads Authority within 5 working days.

(c) Network Manager

Prior to any street lighting design, applications must be made to the Local Roads Authority who will advise on its requirements.

(d) Planning Consents

The developer is responsible for the procurement of listed building or other planning consents as necessary.

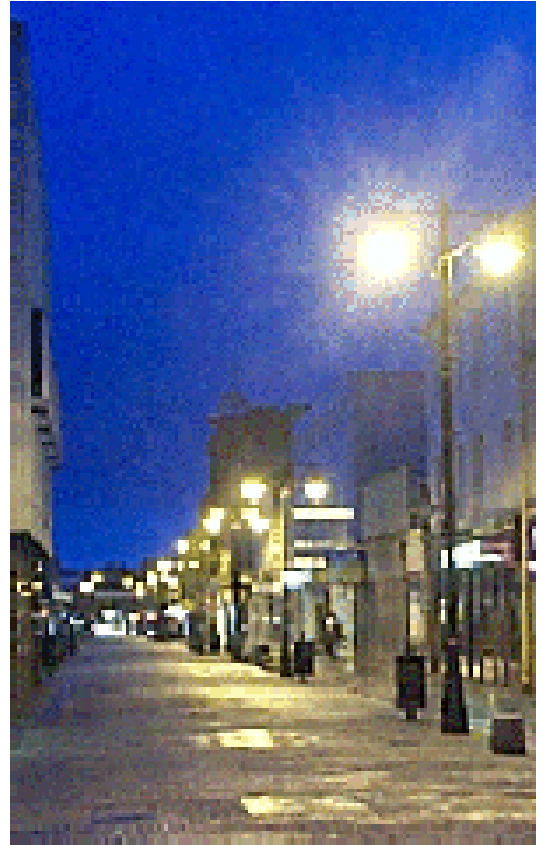

(e) Remedial Action

In the event of failure to meet the specified standards the developer shall effect the necessary remedial actions at his expense within four months or responsibility for operation and maintenance shall revert to him.

(f) Residential Areas

In residential areas columns should be sited with consideration to the house design and remote from the visual line of the main house windows, the preferred position being at the division of property where possible, with allowance for entrances and drives.



(g) Column Siting

Columns must not be sited at the toe of the footway, on service areas or SUDS areas.

(h) Spacing

The distance between any two lighting columns in any direction shall not be less than 15 metres.

(i) Spacing at bends

Where calculations or luminance templates require the spacing on bends to be reduced from the design spacing, the following minimum spacing shall apply:

- ◊ Mounting Height 8 metres
- ◊ Minimum Spacing 20 metres



(j) Electrical Design

Electrical Design

The electrical design shall in all respects comply with the requirements of the '17th Edition of the IEE Wiring Regulations (BS 7671)', Electricity at Work Regulations 1989 [↗](#) and the Roads Liaison Group Well-Lit Highways [↗](#).

Main Supply

Live services from the supply authority will only be taken into distribution pillars.

Distribution Pillars

Distribution pillars shall be sited in the side road away from major traffic routes and the junction itself, in positions where they are least likely to sustain impact or malicious damage whilst being readily accessible for maintenance purposes and to facilitate cable links to the adjacent lighting network.

Road Distribution Circuit

Road Distribution Circuits shall be 230 volt single phase primarily looped in or spurred from road lighting units. All other items of street furniture shall be spurred from a convenient road lighting unit; these spurs looping through two or more such items as appropriate. The maximum number of supply cables entering/leaving a road lighting unit shall be three. The maximum for other items of street furniture shall be two.

Earth Fault Loop Impedance

In the event of the supply earth fault loop impedance not being provided by the supply authority or obtainable by measurement the under note typical values shall be applied:

- ◊ *TN-C-S systems* 0.35 ohms
- ◊ *TN-S system* 0.8 ohms

For fixed equipment which can be touched by persons in contact with the general mass of the earth, including lighting columns and other illuminated street furniture, the earth fault loop impedance shall be such that disconnection under fault conditions occurs within 5.0 seconds. Earth electrodes should be installed at all salient points, ie at each feeder pillar and at the end of the circuits with three or more lighting units.

(k) Drawings

Schematic Circuit Layout

A schematic circuit layout for each feeder pillar shall be provided on all drawings giving:

- (i) *phase and number of circuit;*
- (ii) *size and type of protective device;*
- (iii) *size and type of cables;*
- (iv) *calculated values of line-earth fault loop impedances at all salient points.*

Column and Pillar Numbering

All column and distribution pillars shall be numbered to accord with schematic diagrams.

Protection

All columns and structural steelwork shall be hot dip galvanised. Further protective coatings, if required, shall meet the requirements of the Local Roads Authority.

Geometry and Compatibility

Drawings shall show such detail of contiguous lighting installations that the geometry can be fully assessed and the compatibility of the proposed system confirmed. Alterations to existing services and equipment which the Local Roads Authority deem necessary to accommodate will be charged to the Developer on a time and materials basis.

Roads and Footpath Adoption

Where relevant, roads and footpaths scheduled for adoption shall be clearly differentiated from those that are not.

As-installed Drawings

'As-installed' drawings at 1:500 must be provided prior to adoption. The drawings must also incorporate a legend and symbols as described in Appendix B. The contractor should certify that installation complies with BS 7671 before connecting to network.

3.5 Parking Considerations

3.5.1 The Application of Parking Provision

The consideration of parking provision at any development or redevelopment is an essential attribute that if undertaken correctly will enhance a project. Factors affecting parking provision such as public transport provision and walkable access to services and provisions are recognised in these parking standards.

This guidance reflects the key consideration within **Designing Streets** [🔗](#) (pages 40-43) to integrate parking and encourages a designer to use innovation that whilst making parking provision, reduces the obvious impacts of car or vehicle parks.



3.5.2 Environmental Considerations

Consideration must be given to 'parking' and its relationship to the built environment which it serves. The form and function of the parking can have a determining influence on the successfulness of the development design concept.

Underground, internal and undercroft parking is encouraged and should be considered in all developments to enhance the place making options.

The location of the development itself may have an impact on the way parking is treated. A location near to other attractors such as employment or commercial areas may lead to residential

areas being used as overflow car parks to the adjoining uses. Consideration may need to be given to some form of parking control during working hours to discourage inappropriate parking.

3.5.3 What is a Parking Space?

Car parking provision is usually expressed in terms of 'spaces' and includes car-ports and undercroft parking as well as parking courts but does not include garages under a certain internal dimension.

3.5.4 Parking Standards in Urban Areas

For main urban areas a reduction to the parking standard may be considered. Main urban areas are defined as those having frequent and extensive public transport and cycling and walking links, accessing education, healthcare, food shopping and employment.

3.5.5 Shared Use Provision

Often, especially in urban areas, parking provision can be shared with other uses. For example, many leisure activities in urban areas can rely on existing public parking as leisure peak times are often different to retail peak times.

Shared use of parking areas is highly desirable, provided this works without conflict and that car parking provision is within the standard that requires the most number of car spaces applicable. Conflict should not occur so long as the shared use developments operate at differing times of day or days of the week, or the development is considered ancillary to other activities (ie food and drink within a retail area). Shared use may result in a reduction of the number of parking spaces which a developer is required to provide. For example, a mixed use development of shops, requiring 100 spaces for daytime use and leisure requiring 120 spaces for evening use, can suffice with 120 spaces in total. Where applicable long term agreements should be confirmed as part of the application to support the required parking standards.

Proposals for shared use parking must be supported by a parking appraisal undertaken by the applicant, to a scope agreed with the Roads Authority.

3.5.6 Extensions and Change of Use

Prior to any extension or change of use, the developer must demonstrate that adequate parking provision will be provided.

3.5.7 Commercial Vehicles

Commercial vehicles are regarded as those vehicles delivering goods to or removing goods from premises. It is recognised that servicing requirements may be unique to a particular site. Commercial traffic varies with the type of enterprise within a given use class.

The onus is placed with the developer, who should analyse their development's own requirements in terms of the numbers and types of commercial vehicles visiting their premises and should

demonstrate to the Local Authority that any development proposal includes sufficient commercial vehicle provision to meet normal requirements such as provision for loading, unloading and turning. Such commercial provision should be clearly signed and marked to avoid being utilised as an overflow parking area for cars.

3.5.8 Coaches

Developments likely to generate coach traffic should provide appropriate off-street parking facilities for the stopping, setting down and picking up of passengers as well as appropriate turning facilities (avoiding the requirement for coaches to reverse in or out of a site where possible, taking into consideration pedestrian safety). The onus will be on the developer to demonstrate to the Local Authority the development has the appropriate level of provision.

3.5.9 Provision for Cycle Parking

Cycle Parking Standards should be applied by Local Authorities to all applications for new or extended development. They are expressed as minimum standards to reflect the sustainable nature of this mode of travel.

The provision of convenient secure parking and related facilities are fundamental to attracting modal shift to cycling, particularly from single occupancy motorised journeys made over shorter distances on a regular basis. It is acknowledged that cycle parking demand varies greatly between use classes and a straight ratio of car to cycle trips can not be used to define the Cycle Parking Standard. In addition to the provision of cycle parking, developers will be required to demonstrate that they have considered additional needs for cyclists, such as locker, changing and shower facilities.



Where it is not possible to provide cycle parking spaces on-site, developers will be expected to make a financial contribution towards public provision of such facilities.

For information for cycle parking please refer to the [Cycling by Design](#) or [LTN 2/08 Cycle Infrastructure Design](#).

3.5.10 Provision for Powered Two-Wheeler Parking

The use of Powered Two-Wheeled vehicles (PTW) for short regular journeys can create significant benefits, most notably in the form of reduced congestion and reduced land use for parking.

Parking standards for PTWs are represented as the minimum provision required, which reflects the advantages they have over the car and single occupancy vehicles in particular. As with cycle parking, these standards represent a basis for helping to provide sufficient PTW parking facilities.

In addition to the provision of secure parking, developers will be required to demonstrate that they have considered additional needs for PTW users, such as locker and changing facilities.

UK Government transport statistics show that the ratio between car and PTW ownership is 1:25. However, with regard to the congestion benefits that the PTW provides, a varied ratio parking standard linked to car parking spaces should be applied.

Car Spaces	PTW Spaces
For the first 0-100 spaces	1 space, plus 1 space per 20 car park spaces
Additional spaces over 100	1 per 30 car park spaces

For example a development that proposes a car park of 130 spaces should calculate their PTW requirement in the following way:

<i>1 space provided regardless of car park size</i>	= 1
<i>1 space per 20 car parking spaces for first 100 spaces</i>	= 5
<i>1 space for the remaining 30 car parking spaces</i>	= 1
<i>Total</i>	= 7

3.5.11 Provision for Disabled Parking

Disabled Persons Parking Places (Scotland) Act 2009 [🔗](#)

Under the Disability Discrimination Act 2005 as amended by the [Equalities Act 2010](#) [🔗](#), it is the responsibility of site occupiers to ensure that adequate provision is made for the needs of disabled people. Parking for disabled people will be required for their exclusive use at all sites.

The number of spaces required for disabled motorists varies between classes and the standard has been based on [TAL 6/02 Inclusive Mobility 2002](#) [🔗](#).

Car Park Used for:	Car Park Size	
	200 Bays or Less	Over 200 Bays
Employees and visitors to business premises	(Individual bays for each disabled employee plus) 2 bays or 5% of total capacity, whichever is greater	6 bays plus 2% of total capacity
Shopping, recreation and leisure	3 bays or 6% of total capacity, whichever is greater	4 bays plus 4% of total capacity
<i>Educational Establishments (Advisory)</i>	<i>1 Bay or 5 % of total capacity, whichever is greater</i>	

Note: Disabled parking provision to be included in the overall vehicle parking standard.

If it is known that there will be a disabled employee, then their space should be exclusive of the disabled parking standard required.

It should be noted that a larger number of spaces may be required by the LPA at facilities where a higher proportion of disabled users/visitors will be expected, for example medical, health and care facilities.

The provision at the above levels or any required by the LPA does not guarantee that the requirements of the [Equalities Act 2010](#) will be met, this is the responsibility of the building occupier or service provider.

3.5.12 Planning Obligations

There may be opportunities to accept a S75 developer contribution/obligation in lieu of the full parking standard in sustainable locations. For further guidance on developer contributions, refer to local authority.

3.6 Parking Design and Layout

Parking is a key element in any new development. As well as providing an appropriate level of car parking, it is important that new or extended developments incorporate good design for the layout, landscaping and lighting of parking. This should be user-friendly, and not interfere with the public road or access adjacent to the parking area.

Parking requirements for developments are provided in terms of the planning classification.



3.6.1 Pedestrians

The needs of pedestrians should be taken into account when designing the layout of parking for all modes. This includes both those who have parked and those accessing the development on foot.

Pedestrian access to the development should be considered and pedestrian desire lines identified. Pedestrian access should then be provided along these routes rather than simply relying on the vehicular access.

A tactile distinction should be made between pedestrian areas and vehicular areas, in order that people with visual impairment can distinguish between the two. The provision of raised areas, footway areas and tactile paving at all dropped kerbs should achieve this.

3.6.2 Vehicles

(a) Parking Bay Size

Preferred bay size for cars	5.5m x 2.9
(Parallel parking bay length)	6.0m
Desirable bay size	5.0m x 2.5m

Notes: Minimum bay size for vans	7.5m x 3.5m*
Minimum bay size for HGVs:	
<i>Articulated</i>	17.0m x 3.5m
<i>Rigid</i>	12.0 x 3.5m

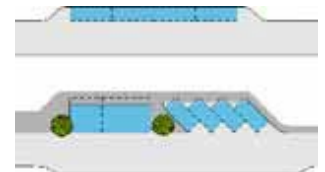

On-street parking Options

* To allow for the trend of increasingly long vans (eg Mercedes-Benz Sprinter - up to 7,345mm; Fort Transit - up to 6,403mm)

Any smaller than the above minimum bay size and an occupant might be unable to get in or out of an average sized family car parked in the bay with cars parked adjacent and consequently bay sizes smaller than the minimum stated above will not be considered a usable parking space.

(b) Layout of Parking Areas

The location and overall design should encourage maximum use of the parking areas in order to minimise the risk of on-street parking problems. As well as taking into account design features such as security and landscaping, adequate bay sizes that are easy to enter and exit and clear directional markings such as exit signs, will increase the appeal of the parking area.

There are a variety of parking styles including:

Square Parking (or 90° Square Parking) Angled Parking

Parallel or 'End to End' Parking

Examples of parking arrangements are shown below:

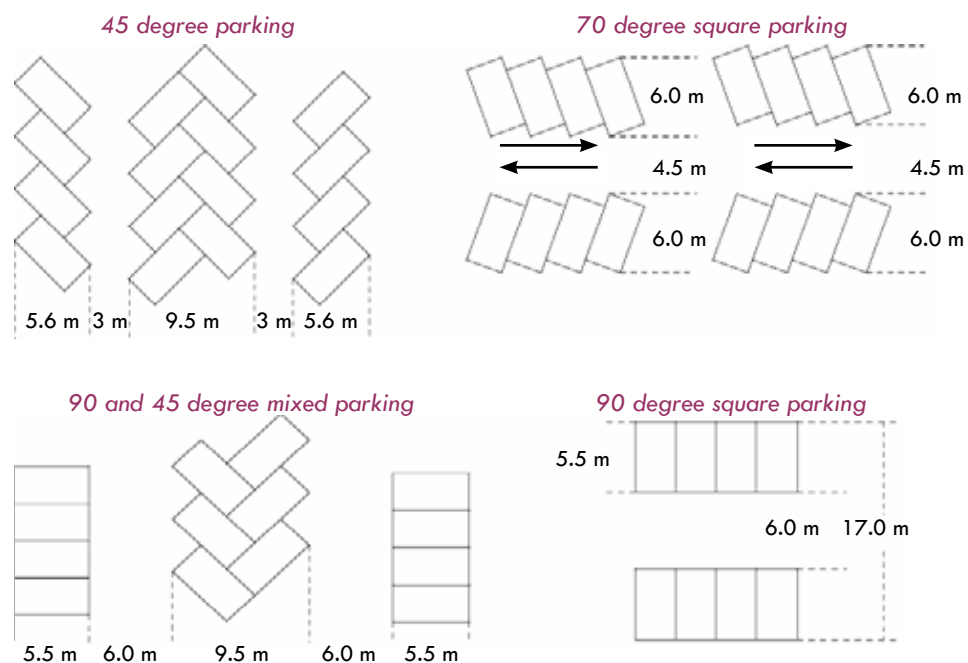

Further guidance can be obtained from the Department for Transport. Although it should be noted that this document recommends large parking bays than DfT guidance, due to the increase in size of the modern car.

Advice regarding Commercial Vehicles can be sought via the Freight Transport Association.



Examples of parking arrangements (note: tree planting photo on right reducing bay size availability to be changed)

3.6.3 Disabled Parking Design

(a) Location of Disabled Parking Bays

Spaces for disabled people should be located adjacent to entrances, where possible, should be convenient to use and the dimension conform to the relevant regulations. At the very most disabled parking spaces should be located no more than 150 m from the site.

(b) Disabled Parking Bay Dimensions

Parking bays for disabled people should be designed so that drivers and passengers, either of whom may be disabled, can get in and out of the car easily and safely. Bays should be longer and wider than a standard bay. This ensures easy access from the side and the rear for those with wheelchairs, and protects disabled people from moving traffic when they cannot get in or out of their car on the footway side of a bay on the road.

Off-street disabled parking bays should be at least 5.5 m long by 2.9 m wide with additional space as follows:

Disabled parking arrangements

Example of bay

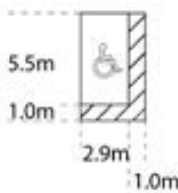

Square Parking

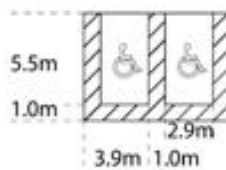

Parallel Parking

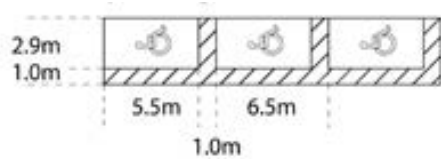

Blue Badge parking at a supermarket

Where bays are parallel to the access aisle and access is available from the side, an extra length of at least 1.0 m.

Where bays are marked perpendicularly to the access aisle, an additional width of at least 1.0m along each side. Where bays are adjacent, space can be saved by using the 1.0m 'side' area to serve the space either side.

When parallel to the access - 6.5 m by 2.9 m

When perpendicular to access - 5.5 m by 3.9 m

(c) Disabled Parking Design Consideration

Bays should be marked with lines and the International Symbol for Access with the safety zone/aisle between the bays marked with hatchings.

Dropped kerbs should be provided where necessary and pedestrian routes to and from car parks for people with disabilities should be free from steps, bollards and steep slopes. Further guidance can be sought from 'Guidance on the use of Tactile Paving Surfaces' DETR.

Further guidance can be obtained from the DfT's Traffic Advisory Leaflet 05/95 (although it should be noted that this information is somewhat out of date), the DfT's Inclusive Mobility document and from BS 8300:2009 Appendix C.

3.6.4 Residential Parking Design

When planning residential parking, consideration of the type and scale of the development should be taken into account. Safe and secure parking can be achieved where cars can be seen by owners and neighbours. Layouts must accommodate the safe passage of emergency, delivery and refuse collection vehicles.

(a) Shared Surface

Where Shared surfaces are deemed appropriate within the street structure, they can offer opportunities for parking to be integrated within the street.

Shared surface design should be appropriate for the location.



Shared surfaces can lead to indiscriminate parking, blocking of footway and the narrowing of the road which hampers access by service and emergency vehicles. Shared Surfaces should therefore only be used in appropriate circumstances, at very low densities.

(b) On-Street Parking Provision

By using careful and innovative design, streets can be made to incorporate a certain level of unallocated on-street parking in the form of parallel or angled parking bays or parking squares. However, consideration must be given to location, proximity to accesses, sight lines and manoeuvring requirements so that indiscriminate parking and the obstruction of footways and carriageways is avoided. It is also important that the requirements of emergency and other service vehicles are catered for together with the needs of the disabled.



*On-street parking options 90 degree!
Boulevard! between trees*

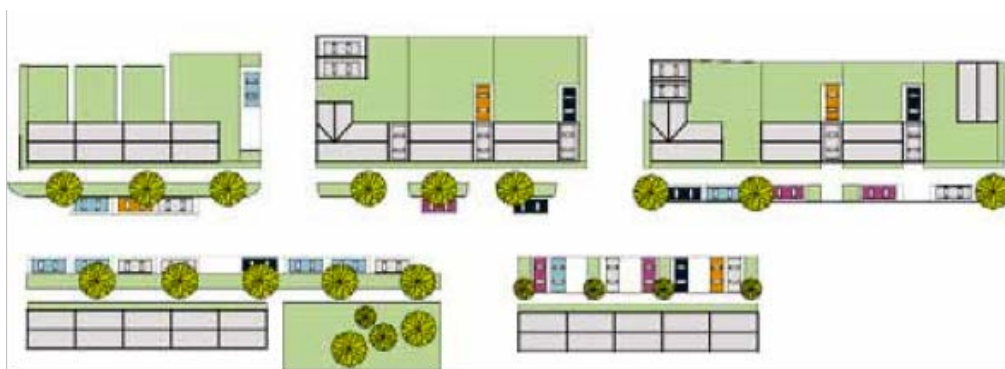

Bus routes within residential developments will require a minimum clear passage which must be available where on-street parking is proposed. Refer to section 3.1.3 and further street design advice is contained in the [Designing Streets](#).

On-street parking spaces which are not allocated to particular dwellings may be considered for adoption by the Road Authority subject to appropriate design. Those which are part of

the allocated parking provision of individual dwellings will not be adopted and therefore the developer must make arrangements for their future management and maintenance.

(c) Parking Squares

These are pedestrian/vehicle shared surfaces, often consisting of a junction of routes. A parking square should be directly fronted by buildings.

Car parking can be provided in those areas which are not occupied by the carriageway or footway. Parking requirements of the frontage dwellings can be accommodated within the square, with the remaining requirement between or behind the dwellings. Clear demarcation between private and public parking is required.

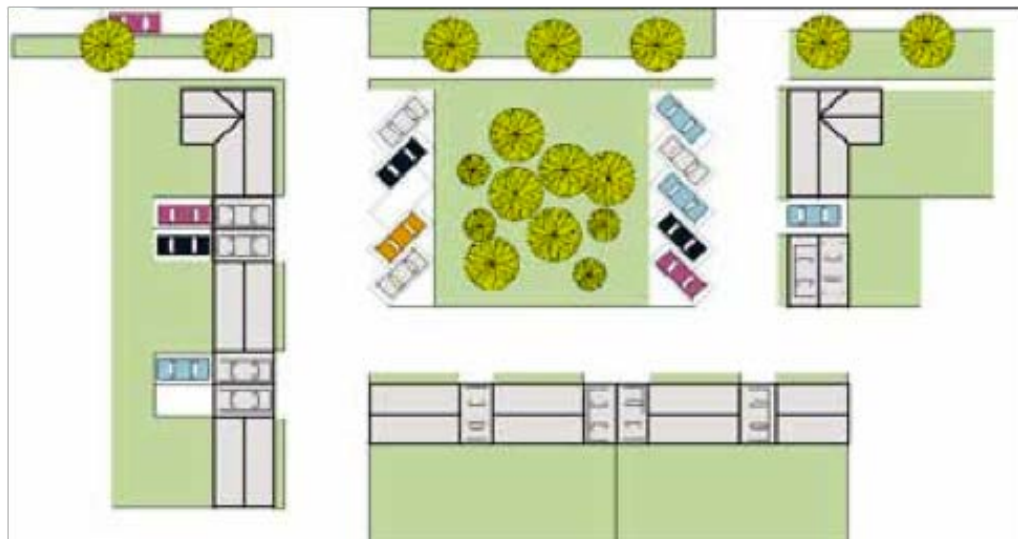

Parking adjacent to landscaped square

Alternative layout includes 90 degree parking

(d) Parking Courts

Parking courts need to be designed carefully and be overlooked with direct access to/from the surrounding dwellings and have adequate lighting. Boundary fencing should be designed to allow observation from dwellings over the parking spaces.

They must be high-quality in design terms and have a sense of place and feel secure, to encourage ownership.

They should not be located in inaccessible areas at the extremity of the development.

Rear parking courts should ideally serve only those properties adjoining the court.

Part 3

ROADS DEVELOPMENT GUIDE

Overlooked rear spaces

*Small courtyard
generously landscaped
using appropriate
planting and quality
materials*

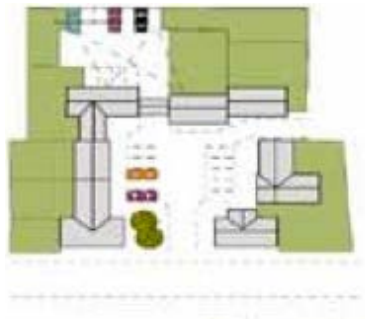

*On plot parking and
small parking courts*

Small parking courts



*Access to properties from
rear parking court*



Overlooked rear parking court

(e) In-Curtilage

Where housing densities are lower, space for car parking can be, in conjunction with careful positioning of the house provided “on plot”, within the curtilage of the dwelling, such that car parking is less obvious, this can be in the form of a garage, car port, parking bay or private drive.

No surface water or loose material will be discharged onto the public road from within a curtilage.

Sufficient unimpeded access aisle space to vehicles giving due regard to disabled uses must be provided.

(f) Garage Provision and Size

It is recognised that despite being an important design feature of residential developments, garages are being used for other purposes, such as general and cycle storage. It is acknowledged that storage space is important, particularly as many properties do not have much storage space within the dwelling itself. It is also known that cars are getting bigger.



A garage can be counted towards a parking space allocation. However, any change of use will result in less availability of parking and increased pressure to on-street parking. For this reason:

- ◊ *Minimum Garage size for Cars* *7.0 m x 3.0 m (internal dimension)*
- ◊ *Associated minimum clear door access dimensions* *2.1m wide x 1.98m height*

Garages of the above dimension and over will be considered a parking space as they are large enough to accommodate the average sized family car and cycles, as well as some storage space. To encourage garage use, functionality is equally important therefore reasonable access and egress from a car within a garage is essential. Additionally, provision for electric vehicle charging facilities should be provided with a garage space.

(g) Mixed Use Streets

In certain areas residential development will form part of a wider mixed use development where other uses (retail/business) will dominate at ground floor level.

(h) Underground, Underdeck and Undercroft Parking

For developments of higher dwelling density, it is unlikely that sufficient space for car parking can be provided by in-curtilage and garage provision (without a detrimental effect on the quality of the development).



Underground, underdeck or undercroft parking should be provided wherever possible.



Underground parking with communal space above

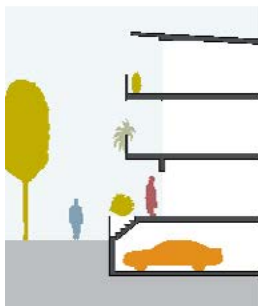

Partial underground parking with raised floor

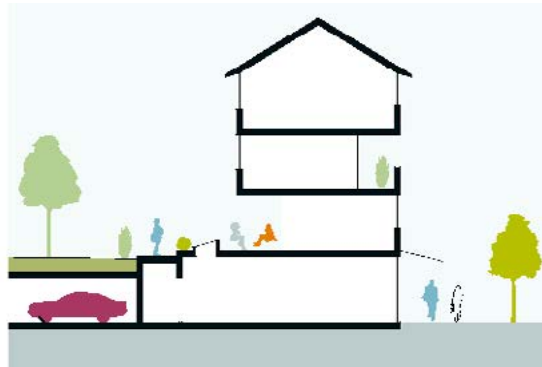

Single aspect ground floor uses with rear Underdeck access

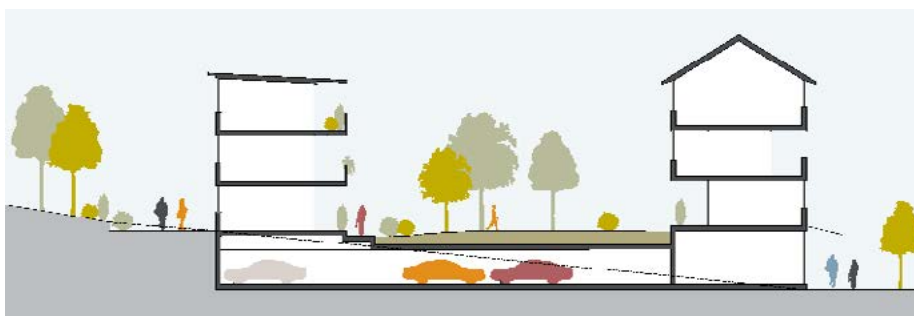

Underground parking using ground slope



Locating car parking either under buildings, above or below ground level, can significantly improve the quality of a development. Planning Authorities will need to ensure that underground underdeck and undercrofts parking are safe, secure and retained for parking.

(i) Tandem Parking

Tandem Parking should be discouraged where possible especially in parking courts, as studies have shown that their use for parking is reduced, often used instead for bin storage, and that their provision encourages on-street parking.

(j) Set Backs

Construction of garages or gates adjacent to the road using a previous standard 1.5m setback have led to widespread abuse by residents who use this area plus the adjacent footway/cycleway/verge to park vehicles perpendicular to the main carriageway. This creates an obstruction of the footway/cycleway and whilst this is an enforcement issue in existing situations, it is appropriate to amend the standard so that this does not occur as frequently in future.

In order to reduce occurrences in future, the following standard should be adopted. Where garages/gates (all gates to open inwards) are placed directly adjacent to the road the setback should be either:

- (1) *no more than 0.5 m to allow for the opening of the garage door and with the adjacent distance between edge of road and edge of carriageway being no more than 2 m. This gives a maximum distance between garage/gate and running carriageway of 2.5 m, thus discouraging inappropriate parking;*
- (2) *greater than 6 m from the edge of the road to allow for parking in front of the garage/gates. In these circumstances there no need to restrict the width of the adjacent footway/cycleway/verge as there is less likelihood of abuse.*

Good Practice Examples

Top left: Setback in excess of 1.5m, yet with parking restrictions to prevent obstruction.

Top right: Parking space clear of footway, in line with vegetation.

Bottom left: Reduced setback but demarcated to show footway limit and allow room for garage door to open.

Bottom right: Setback in excess of 1.5m, yet parking can occur between dwelling and landscaping (trees), causing no obstruction to footway/ carriageway



(1a) Up and over garage door

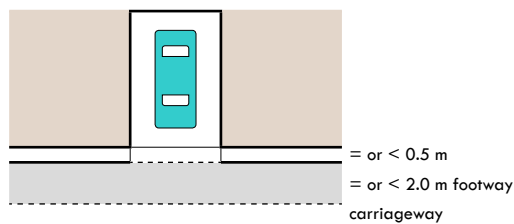

(1b) Gates

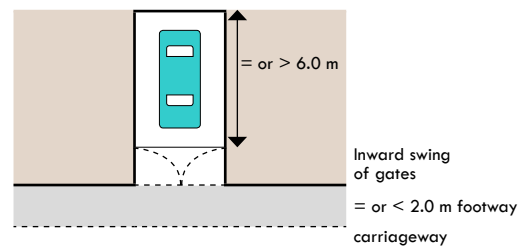

(2) Driveway

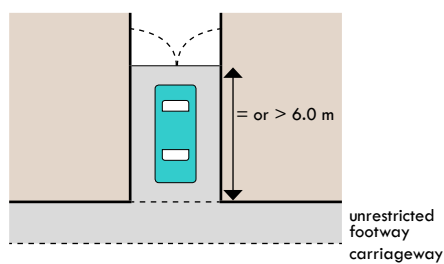

(k) Retirement/Warden Controlled Developments

Many residents are car owners and parking should be provided for each unit unless there is the evidence base to support a reduction in the standard. Additionally, parking provision should be made for visitors who support the residents of such developments, carers, health visitors, etc.

Consideration should be given to safe storage and charging point locations for mobility scooters when designing Retirement/Warden Controlled Developments.

3.6.5 Powered Two-Wheeler Parking Design

(For general advice on design for M/C, refer to [Guidelines for Motorcycling](#) )

In terms of convenience, flexibility and security PTW's have the same characteristics as cycles. Consequently the behaviour and requirements of the powered two wheeler rider often follow that of the cyclist.

Powered two wheeler parking should be clearly signposted from the road and signed in situ, indicating that it is reserved for powered two wheelers only. Sites should have anchor points, quality level surfacing, CCTV and/or natural surveillance, be located away from drain gratings and protected from the elements as well as having good lighting. For long stay parking, such as workplaces, lockers to allow storage of clothing and equipment and changing facilities should be provided. PTW parking can be vulnerable locations, particularly long stay parking. Ideally there should only be access for PTW's, not vehicles, which can be done by using a causeway or pinch point. The parking area should be in a wide open location, not in an isolated, secluded place.



Note: cobbles are not appropriate surface treatment for PTW parking

Motorcycle parking bays are generally not marked out for individual machines, allowing flexible and efficient use of limited space by machines of different sizes. Consideration should also be given to height clearance, with many bikes measuring upwards of 1.5 m not including the rider.

- Preferred bay size for a PTW 2.5 m x 1.5 m
- Absolute minimum bay size 2 m x 0.8 m
- With a minimum space of 1 m between each bike.

Provision should be made in which to secure PTWs. There are 2 basic types of anchor points to which motorcycles can be secured to reduce the risk of theft:

- **Ground Level** - An anchor point below the surface, with a loop allowing the user's own lock to be passed through. Anchor points require regular maintenance and can be dirty to use.

- **Raised** - A horizontal bar is provided at a height of approximately 400-600 mm and requires the user to use their own lock. The continuous rail allows for efficient use by machines of varying style and size, is well understood by users and is compatible with most types of shackling devices.

Further information can be sought from the [DfT's Traffic Advisory Leaflet 2/02](#).

3.6.6 Cycle Parking Design

Key considerations regards cycle parking is referred to in [Designing Streets](#) (page 40). Providing well-located, safe and secure cycle parking is a key factor in encouraging people to cycle as an alternative to using the private car. Further guidance can be found in [Cycling by Design](#) and [LTN 2/08 Cycle Infrastructure Design](#).

All cycle parking must be overlooked, sheltered from strong winds and be Well Lit.



Long stay cycle parking, for example for employees, should include secure, covered cycle storage situated close to the building but preferably out of sight to the general public (possibly to the rear of the building), to reduce the chance of theft or tampering. Facilities should be present such as showers, changing rooms and lockers.

Short-term cycle parking, for example, for shoppers or visitors should be secure and ideally covered and situated as close to the main entrance as possible. The location should be highly visible to people, thus reducing the chance of theft or tampering.



Normally Sheffield stands should be provided. Stands that grip only the front wheel do not provide adequate support or security. When placed 1 m apart and 0.5 m from the wall, Sheffield stands can accommodate two cycles. Where more than two stands are required, you may need to provide a 'toast rack' facility.

Where children are likely to attend (schools, leisure facilities etc) an extra horizontal bar at 650 mm above ground level or a reduced sized stand to support the smaller frame of a child's cycle should be considered.

More detailed information can be found in the Scottish Government's publication [Cycling by Design](#) . [Sustrans](#) , the UK's national cycling organisation can also provide detailed design information.

Care should be taken to ensure that the cycle parking (when in use) does not cause an obstruction to pedestrian flow.

3.7 Parking Standards for Use Classes

Class 1: Shops

Retail sale of goods, hairdresser, undertaker, travel and ticket agency, post office. Dry cleaner, laundrette, cold food consumption on premises. Display of goods for sale, hiring out of domestic goods or articles, reception of goods to be washed.

Type of Development	Vehicle Maximum (spaces per 100 m ² gross floor area, GFA)	Cycle Minimum	PTW Minimum	Disabled Minimum
Shops				
City Centre	2 spaces	1 space per 400 sqm for staff and 1 space per 400 sqm for customers	1 space + 1 per 20 car spaces (for first 100 car spaces), then 1 space per 30 car spaces (over 100 car spaces)	200 bays or less = 3 bays or 6% of total capacity, whichever is greater Over 200 bays = 4 bays plus 4% of total capacity
Other centres	3 spaces			
Food Superstore				
0-500 m ² GFA	5 spaces			
500-2,000 m ² GFA	6.5 spaces			
2,000-8,000 m ² GFA	7 spaces			
>8,000 m ² GFA	6 spaces			

Use	Vehicle Maximum (spaces per 100 m ² gross floor area, GFA)	Cycle Minimum	PTW Minimum	Disabled Minimum
Shopping Centre				
0-500 m ² GFA	4 spaces			
500-2,000 m ² GFA	5 spaces			
2,000-8,000 m ² GFA	6 spaces			
>8,000 m ² GFA	5 spaces			
Retail Park				
2,000-8,000 m ² GFA	2 spaces			
>8,000 m ² GFA	2.2 spaces			
DIY Superstore				
2,000-8,000 m ² GFA	2 spaces			
>8,000 m ² GFA	2.2 spaces			

Informative Notes

Parking standards for large, stand-alone developments, such as large department stores and shopping centres will be considered on a case by case basis and should be agreed with the relevant Local Planning and Road Authorities.

In all cases adequate provision should be made for the parking and turning of service vehicles, serving the site, off the road.

A lower provision may be appropriate in town centre locations where there is good access to alternative forms of transport and existing car parking facilities.

Class 2: Financial, Professional and Other Services

Financial, professional or any other service expected in shopping areas, eg betting office, lawyers, accountants, estate agents, health centres, surgeries of dentists, doctors and vets (where the principal visitors are members of the public).

Type of Development	Vehicle Maximum (spaces per 100 m ² gross floor area, GFA)	Cycle Minimum	PTW Minimum	Disabled Minimum
A2	1 space per 20 sqm	1 space per 100 sqm for staff + 1 space per 200 sqm for customers	1 space + 1 per 20 car spaces (for first 100 car spaces), then 1 space per 30 car spaces (over 100 car spaces)	<p>200 bays or less = 2 bays or 5% of total capacity, whichever is greater</p> <p>Over 200 bays = 6 bays plus 2% of total capacity</p>

Informative Notes

A lower provision may be appropriate in town centre locations where there is good access to alternative forms of transport and existing car parking facilities. In all cases adequate provision shall be made for the parking and turning of service vehicles serving the site, off the highway.

Class 3: Food and Drink

Restaurant, café, snack bar (use for sale of food or drink on the premises).

Type of Development	Vehicle Maximum (spaces per 100 m ² gross floor area, GFA)	Cycle Minimum	PTW Minimum	Disabled Minimum
A3 (excluding Transport Cafés)	1 Space per 5 sqm	1 Space per 100 sqm for staff + 1 space per 1 sqm for customers	1 Space + 1 per 20 car spaces (for first 100 car spaces), then 1 space per 30 car spaces (over 100 car spaces)	200 bays or less = 3 bays or 6% of total capacity, whichever is greater Over 200 bays = 4 bays plus 4 % of total capacity
A3 (Transport Cafés)	1 lorry space per 2 sqm	1 space per 200 sqm for staff + 1 space per 200 sqm for customers		

Informative Notes

A lower provision of vehicle parking may be appropriate in town centre locations where there is good access to alternative forms of transport and existing car parking facilities.

In all cases adequate provision shall be made for the parking and turning of service vehicles serving the site, off the road.

Class 4: Business

Offices (other than that specified under Class 2), research and development of products or processes, light industry.

Type of Development	Vehicle Maximum (spaces per 100 m ² gross floor area, GFA)	Cycle Minimum	PTW Minimum	Disabled Minimum
B1	1 space per 30 sqm	1 space per 100 sqm for staff + 1 space per 200 sqm for visitors	1 space + 1 per 20 car spaces (for first 100 car spaces), then 1 space per 30 car spaces (over 100 car spaces)	200 bays or less = 2 bays or 5% of total capacity, whichever is greater Over 200 bays = 6 bays plus 2% of total capacity

Informative Notes

A lower provision of vehicle parking may be appropriate in town centre locations where there is good access to alternative forms of transport and existing car parking facilities.

In all cases adequate provision shall be made for the parking and turning of service vehicles serving the site, off the road. Consideration should also be given to the requirement for any overnight parking and facilities.

Class 5: General Industrial

General industrial (use for the carrying out of an industrial process other than one falling within the Class 4 (Business) definition).

Type of Development	Vehicle Maximum (spaces per 100 m ² gross floor area, GFA)	Cycle Minimum	PTW Minimum	Disabled Minimum
B2	1 space per 50 sqm	1 space per 250 sqm for staff + 1 space per 500 sqm for visitors	1 space + 1 per 20 car spaces (for first 100 car spaces), then 1 space per 30 car spaces (over 100 car spaces)	<p>200 bays or less = 2 bays or 5% of total capacity, whichever is greater</p> <p>Over 200 bays = 6 bays plus 2% of total capacity</p>

Informative Notes

A lower provision of vehicle parking may be appropriate in town centre locations where there is good access to alternative forms of transport and existing car parking facilities.

In all cases adequate provision shall be made for the parking and turning of service vehicles serving the site, off the road. Consideration should also be given to the requirement for any overnight parking and facilities.

If a site office is included in the development then a B1 parking standard should be applied for that area.

Class 6: Storage or Distribution

Storage or distribution.

Type of Development	Vehicle Maximum (spaces per 100 m ² gross floor area, GFA)	Cycle Minimum	PTW Minimum	Disabled Minimum
	1 space per 150 sqm	1 space per 500 sqm for staff + 1 space per 1,000 sqm for visitors	1 space + 1 per 20 car spaces (for first 100 car spaces), then 1 space per 30 car spaces (over 100 car spaces)	200 bays or less = 2 bays or 5% of total capacity, whichever is greater Over 200 bays = 6 bays plus 2% of total capacity
Lorry Parking				
<i>Factories and Warehouses</i>	1.1 spaces			
<i>Warehousing (non-sales)</i>	0.5 spaces			
<i>Business Park</i>	2 spaces			
<i>Science Park</i>	2 spaces			

Informative Notes

A lower provision of vehicle parking may be appropriate in town centre locations where there is good access to alternative forms of transport and existing car parking facilities.

In all cases adequate provision shall be made for the parking and turning of service vehicles serving the site, off the road. Consideration should also be given to the requirement for any overnight parking and facilities.

It is acknowledged that there is an increasing trend for B8 developments with a retail element where there is the option for customers to visit a counter at the premises and make purchases, for developments such as this, additional customer parking should be allocated, equivalent to the A1 standard for the floor space that has public access.

If a site office is included in the development then a B1 parking standard should be applied for that area.

Class 7: Hotels and Hostels

Hotel, boarding and guest house, hostel.

Type of Development	Vehicle Maximum (spaces per 100 m ² gross floor area, GFA)	Cycle Minimum	PTW Minimum	Disabled Minimum
Hotel and B&B	1 space per 2.5 bed spaces	1 space per 5 staff for staff + 1 space per 10 bedrooms	1 space + 1 per 20 car spaces (for first 100 car spaces), then 1 space per 30 car spaces (over 100 car spaces)	200 bays or less = 3 bays or 6% of total capacity, whichever is greater Over 200 bays = 4 bays plus 4% of total capacity
Hostel	1 space per 4 staff plus customer parking on individual merits	1 space + 1 per 20 car spaces (for first 100 car spaces), then 1 space per 30 car spaces over 100 car spaces)	1 space per 40 sqm	

Informative Notes

A lower provision may be appropriate in town centre locations where there is good access to alternative forms of transport and existing car park facilities. The modern day hotel is seldom used solely as a hotel and often offers multifunctional amenities such as conference facilities, restaurants and gyms. These multifunctional uses must be considered per individual class use and adequate parking allocated to encompass all uses when considering the potential for cross- visitation.

Class 8: Residential Institutions

Residential school, college, training centre, residential accommodation with care, hospital, nursing home.

Type of Development	Vehicle Maximum (spaces per 100 m ² gross floor area, GFA)	Cycle Minimum	PTW Minimum	Disabled Minimum
Residential Care Home	1 space per staff member + 1 visitor space per 3 beds	1 space per 5 staff	1 space +1 per 20 car spaces (for 1st 100 car spaces), then 1 space per 30 car spaces (over 100 car spaces)	Dependant on actual development, on individual merit, although expected to be significantly higher than business or recreational development requirements
Hospital	1 space per 3 beds + 1 space per doctor/ surgeon + 1 space per 3 other staff	1 space per 4 staff Visitors - to be considered on a case by case basis		
Treatment Centres (eg ISTC (Independent Sector Treatment Centre) with overnight facilities)	4 spaces per consulting room + 1 space per practitioner + 1 space per 3 other staff	1 space per 4 staff Visitors to be considered on a case by case basis		
Education Establishments - Primary/ Secondary	1 space per staff member + provision for buses where required	1 space per 5 staff + 1 space per 3 students		
Residential Education Establishments - Further/Higher	1 space per staff member + 1 space per 10 students	1 space per 5 staff + 1 space per students		

Informative Notes

Parking Standards for retirement developments that are warden assisted yet provide independent living should fall under Class C3.

Hospital Parking: With regard to parking, it should be acknowledged that particular needs of hospitals arising from their 24 hour service (which impacts on accessibility for patients and visitors and on staff working patterns) should be taken into account and parking provision provided accordingly.

The impact of parking on the surrounding area should be considered and if necessary provide appropriate

traffic management measures (eg resident parking scheme) to prevent illicit parking on neighbouring streets by people travelling to the hospital site. Travel plans for staff, patients and visitors play an important role in traffic reduction and especially encourage modal shift for staff.

Class 9: Houses

House occupied by a single person, or a number living together as a family, or as a household of 5 persons or less. Limited use as a bed and breakfast or guest house.

Trip Origin

Dwellings are predominantly travel origins as opposed to destinations. Previously parking standards have attempted to reduce car use by restricting parking spaces at origin and destinations. It is now recognised that providing a reduced number of parking spaces at a travel origin does not discourage people from owning a car. Therefore parking standards for origins should be used as a minimum standard. For travel destinations the standard will continue to be a maximum.

Standard

Flats and Houses are to be treated the same, with parking standards decided by the number of bedrooms the dwelling has.

Type of Development	Appropriate Provision (spaces per 100 m ² gross floor area, GFA)	Cycle Minimum	PTW Minimum	Disabled Minimum
1 Bedroom	1 space per dwelling	1 secure covered space per dwelling. None if garage or secure area is provided within cartilage of dwelling.	N/A	N/A if parking is in cartilage of dwelling, otherwise as Visitor/ Unallocated
2-3 Bedroom	2 spaces per dwelling*			
4 Bedroom	3 spaces per dwelling			
Retirement Developments (eg warden assisted independent living accommodation)	1 space per dwelling	1 space per 8 units (visitors)	1 space + 1 per 20 car spaces (for 1st 100 car spaces), then 1 space per 30 car spaces (over 100 car spaces)	N/A if parking is in cartilage of dwelling, otherwise as Visitor/ Unallocated

Type of Development	Appropriate Provision (spaces per 100 m ² gross floor area, GFA)	Cycle Minimum	PTW Minimum	Disabled Minimum
Private Sheltered Housing and Housing Associations	0.2-0.5 spaces per dwelling + 0.3 spaces visitor parking per dwelling + 1 space per warden			
Amenity Housing	0.5 spaces per dwelling + 0.3 spaces visitor parking per dwelling			
Local Authority Sheltered Housing	0.25 spaces per dwelling + 1 space per warden			
Visitor/ Unallocated	0.25 spaces per dwelling (unallocated)	If no garage or secure area is provided within cartilage of dwelling then 1 covered and secure space per dwelling in a communal area for residents plus 1 space per 8 dwellings for visitors	1 space +1 per 20 car spaces (for 1st 100 car spaces), then 1 space per 30 car spaces (over 100 car spaces)	200 bays or less = 3 bays or 6% of total capacity, whichever is greater Over 200 bays = 4 bays plus 4% of total capacity

* Excluding garage if less than 7 m x 3 m internal dimension

Informative Notes

Standards excluded garages under 7 m x 3 m (internal dimension) as a parking space but can include undercroft parking and car ports providing they have no other use.

Visitor/unallocated vehicle parking can, subject to appropriate design, be located on or near the road frontage.

Unallocated cycle parking for residents to be secure and covered, located in easily accessible locations throughout the development.

Reductions of the standard may be considered if there is development within an urban area that has good links to sustainable transport.

Class 10: Non-Residential Institutions

Crèche, day nursery, day centre, provision, provision of education, museum, exhibition hall, public library, display of art, public worship, religious instruction, social activities of a religious body.

Type of Development	Vehicle Maximum (spaces per 100 m ² gross floor area, GFA)	Cycle Minimum	PTW Minimum	Disabled Minimum
Crèche, Child Care	1 space per full-time equivalent staff + drop off/pick-up facilities	1 space per 4 staff + 1 space per 10 child places	1 space + 1 per 20 car spaces (for first 100 car spaces), then 1 space per 30 car spaces (over 100 car spaces)	1 bay or 5% or total capacity, whichever is greater
Day Care Centre	1 space per full-time equivalent staff + drop off/pick-up facilities	1 space per 4 staff		1 bay or 5% or total capacity, whichever is greater
Community Centres	5.0- 20.0 m ² GFA			
Education - Primary/Secondary	1 space per 15 pupils	1 space per 5 staff + 1 space per 3 pupils	1 space + 1 per 20 car spaces (for first 100 car spaces) then 1 space per 30 car spaces (over 100 car spaces)	1 bay or 5% of total capacity, whichever is greater
Education - Further/Higher	1 space per 2 staff + 1 space per 15 students for student parking	1 space per 5 staff + 1 space per 3 students		
Art Galleries, Museums, Public/Exhibition Hall	1 space per 30 sqm ² public display space + 1 space per 2 staff	10 spaces + 1 space per 10 vehicle space		200 bays or less = 3 bays or 6% of total capacity whichever is greater
Places of Worship	1 space per 10 seats	1 space per 4 staff + visitor parking (individual merits)		Over 200 Bays = 4 bays plus 4% of total capacity
Libraries	3 spaces + 1 space per 3 staff			
Crematoria	1 space per seat			

Informative Notes

A lower provision may be appropriate for educational establishments in an urban location where there is good access to alternative forms of transport to allow sustainable travel.

The relationship between a school and the residential area is important and falls within the operational requirements of the school. Schools should represent the heart of the community and community facilities should be considered within the school site.

Special Schools parking/drop-off arrangements must be taken into consideration as generally extra staff are required and most pupils/students arrive by taxi or car. Coach parking and facilities must be considered for all D1 uses.

Class 11: Assembly and Leisure

Cinema, concert hall, bingo hall, casino, dance hall, discotheque, skating rink, swimming bath, gymnasium or for indoor sports or recreation not involving motorised vehicles or firearms.

Type of Development	Vehicle Maximum (spaces per 100 m ² gross floor area, GFA)	Cycle Minimum	PTW Minimum	Disabled Minimum
Cinema/Bingo Halls	1 space per 10 seats	10 spaces + 1 space per 10 vehicle space	1 space + 1 per 20 car spaces (for first 100 car spaces), then 1 space per 30 car spaces (over 100 car spaces)	200 bays or less = 3 bays or 6% or total capacity, whichever is greater Over 200 bays = 4 bays plus 4% of total capacity
Theatres/Concert Halls	1 space per 5 seats			
Team Sports (outdoor sports pitches)	20 Spaces	10 spaces plus		
Sports Centres <i>Swimming Pools</i>	10 spaces per 100 sqm ² of pool area	10 spaces + 1 space per 10 vehicle space		
<i>Snooker Halls/ Other Facilities</i>	1 space per table			
Golf Clubs	3 spaces per hole	Individual merit		
Other Sports Facilities	Individual merit	Individual merit		
Dance Halls/Discotheques	10 spaces + 1 space per 3 staff + 3 spaces for performers			

Informative Notes

Coach parking and facilities must be considered for all uses.

Other: Sui Generis

Type of Development	Vehicle Maximum (spaces per 100 m ² gross floor area, GFA)	Cycle Minimum	PTW Minimum	Disabled Minimum
Garden Centres (see <i>informative notes</i>) 0-2,000 m ² GFA 2,000-5,000 m ² GFA >5,000 m ² GFA	1 space per full-time staff equivalent 5.5 5.0 4.0	1 space + 1 per 20 car spaces (for first 100 car spaces), then 1 space per 30 car spaces)	200 bays or less = 3 bays or 6% of total capacity, whichever is greater. Over 200 bays = 4 bays plus 4% of total capacity 200 bays or less = 3 bays or 6% of total capacity whichever is greater Over 200 bays = 4 bays plus 4% of total capacity	
Student Flats	1 space per 7 students + 1 space per 3 staff + 1 space per wardem			

Part 3

ROADS DEVELOPMENT GUIDE

Type of Development	Vehicle Maximum (spaces per 100 m ² gross floor area, GFA)	Cycle Minimum	PTW Minimum	Disabled Minimum
Motor Trade				
Vehicle display area	2 spaces			
Spares department	4 spaces			
Servicing/ bodywork	4 per service bay			
Tyre and exhaust centre	2 per service bay			
Car wash	5 queuing spaces			
Scrapyards	2 spaces			
Staff	1 space per 2 staff			
Public Houses	10 spaces			

Informative Notes

Coach parking and facilities must be considered for all uses.

Multifunctional uses must be considered per individual class use and adequate parking allocated to encompass all uses, when assessing the parking requirements of a development, taking into account cross-visitation.

A lower provision of vehicle parking may be appropriate in urban locations where there is good access to alternative forms of transport and existing car parking facilities.

3.8 Structures Technical Approval

Structures Technical Approval Requirements

From clauses 2.8.2 and 2.8.3 of the COP:

“All structural design and assessment should be subject to a formal Technical Approval procedure such as those used by the Highways Agency [BD 2; Technical Approval of Highway Structures, 43] or Network Rail [GC/RT5J OJ Technical Approval Requirements for Changes to the Infrastructure, 44”

The Local Authorities are the Technical Approval Authority (TAA) for all road structures and pedestrian footbridges that are owned by each Council (independent of maintenance responsibility).

Whilst the scope of **BD 02/12 (available June 2014)** [↗](#) and **HD 22/08** [↗](#) fully apply, Structures requiring technical approval are summarised below:

- *All road retaining structures greater than 1.5 m in height require technical approval in accordance with **BD 02/12 (available June 2014)** [↗](#).*
- *All culverts and bridges greater than 2 m in span, or greater than 0.9 m in diameter for corrugated steel pipes require technical approval in accordance with **BD 02/12 (available June 2014)** [↗](#).*
- *Any geotechnical works (ie embankments) “which may pose a risk to the general public, the Overseeing Organisation and/or the Overseeing Organisations’s asset” require Technical Approval in accordance with **HD 22/08** [↗](#).*

It is highly recommended that early involvement with the Local Authority Structures team is established for all schemes involving the above.

3.9 SUDS Schedule

The following Sustainable Urban Drainage System details (only forming a part of the road drainage system) are required to be submitted as part of the Road Construction Consent/Technical Approval to clearly convey the standards and responsibilities identified between Local Authorities/Scottish Water.

1. Site layout plan.
2. Type of SUDS - justification for SUDS selected.
3. Marked plan clearly showing responsibility for any particular part of the system - SW/LA/Another (if appropriate) along with construction details.
4. A maintenance schedule should be produced for each scheme, detailing what, when and how.
5. Agreed discharge rates to be incorporated into design details. Details of where discharging to, ie Sewer or watercourse should be clearly stated.
6. Planting details (where appropriate).

7. Whole life costs including decommissioning plan.
8. Where SUDS are within a private curtilage clear evidence of householders responsibilities to maintain. Scottish Water and LA to agree appropriate action should consequential overspill or polluting of associated SUDS takes place.
9. When sacrificial SUDS are to be used during construction, full detail including decommissioning plan to be provided.
10. Independent design certificate (similar to structures) to be provided for the overall drainage Design including SUDS.
11. Confirmation that all required parallel approvals have been obtained, ie SW/SEPA/SNH etc*
12. Consultant certification - written confirmation that consultant can design SUDS**
13. Identify appropriate Professional Indemnity for the above.
14. Adoption of road, including SUDS must coincide with Scottish Water vesting the associated sewer network.*
15. Depending on type of SUDS, eg membrane lined soakaways etc, the road will need to be entered into symology as of 'engineering difficulty'.
16. SUDS Schedule Points to be included in RCC/Technical Approval.
17. Construction detail including design calculations - who installed/when installed (these details to form part of a maintenance schedule).
18. Maintenance schedule to include methodology for disposal of SUDS waste, eg silt from ponds, contaminates grass and plant cuttings (arisings).
19. CCTV survey of systems (where appropriate).
20. Health & Safety Plan/inclusion in CDM Safety file.
21. Contractor certification - written confirmation that contractor can deliver SUDS?***
22. Defects period - a minimum of 24 months will be required to ensure the SUDS system has been established. A reasonable portion of the road bond may be retained in accordance with Regulation 15.
23. Specification
Measures to be used to independently test the suds system performance before adoption is required this should include the following:

- ◊ *sewer pipes shall be tested in accordance with Sewers for Scotland Third Edition* ;

- ◊ road drainage pipes shall be air or water tested to **BS EN 1610** [↗](#) and where velocities are less than 1 m/s a Mandrel Test may be required where appropriate;
- ◊ infiltration systems shall be tested in accordance with Appendix B of **SUDS Manual, CIRIA no C753** [↗](#) to determine suitability. Thereafter a test load will be applied and timed to ensure the design infiltration rate is being achieved;
- ◊ ponds and basin will require the following tests:
 - fill pond to test overflow facility operates correctly;
 - control device tested against design head to verify agreed greenfield runoff rate being achieved (flow measurement device may be required);
 - fill pond to undertake drop test to ensure no leakage; and
 - fill pond to test required storage capacity has been provided.

This may be achieved by extending the testing period to allow for the pond and basin to be filled naturally by rainfall.

References made to a suite of SCOTS/Scottish Water drawings (click on image opposite) at this stage shows potential splits in maintenance responsibilities. This work in relation to Section 7 Agreement is ongoing.

Appendices

ROADS DEVELOPMENT GUIDE



Click map to see regional variations



Glossary
Acronyms
Application Forms
Local Authority Variations

APPENDICES

Appendices

ROADS DEVELOPMENT GUIDE

Appendices

Glossary	179
Acronyms	186
Application Forms	188
Local Authority Variations	189

Glossary

Adsorption

The adherence of gas, vapour or dissolved matter to the surface of solids.

Adopted road

*

Antecedent conditions

The wetness of a catchment prior to a particular rainfall event.

Attenuation

Reduction of peak flow and increase of duration of runoff during and following a storm event.

Base

The lowest bound layer of an asphalt pavement, formerly known as roadbase.

Basins

A ground depression acting as a flow control or water treatment structure that is usually dry and has a proper outfall, but is designed to detain stormwater temporarily.

Binder

The second layer of an asphalt pavement, formerly known as basecourse.

Biodegradation

The decomposition of organic matter by micro-organisms and other living things.

Bioretention areas

A landscaped ground depression that collects runoff so that it percolates through the soil below into an underdrain system, thus promoting pollutant removal.

California Bearing Ratio

An empirical measure of the stiffness and strengths of soils, used in road pavement design.

Capping layer

A layer of unbound aggregate of lower quality than sub-base that is used to improve the performance of the foundation soils before laying the sub-base and protect the sub-grade from damage by construction traffic.

Carriageway

The portion of the road which is used to carry vehicular traffic.

Catchment

The area which contributes surface water flow to a point in a drainage system. Can be split into sub-catchments.

Climate change

Climate change refers to any significant change in measures of climate (such as temperature, precipitation, or wind) lasting for an extended period (decades or longer).

Combined sewer

A sewer which is designed to carry both foul sewerage and surface water in the same pipe.

Combined Sewer Overflows

Overflow systems built into combined sewer networks which allow a certain amount of flow to discharge directly into a watercourse untreated, to ensure the sewer network does not become surcharged in storm conditions.

Control structures

A structure to control the flow rate or volume of water passing through or over it.

Controlled waters

Water defined and protected under the Water Resources Act 1991. Any relevant territorial waters that extend seaward for three miles from the baselines, any coastal waters which extend inland from those baselines to the limit of the highest tide or the freshwater limit of any river or watercourse, any enclosed dock which adjoins coastal waters, inland freshwaters, including rivers, watercourses, and ponds and lakes with discharges and ground waters (waters contained in underground strata). For the full definition refer to the Water Resources Act 1991.

Conveyance

The movement of water from one location to another.

Diffuse pollution

Pollution arising from land-use activities (urban and rural) that are dispersed across a catchment or sub-catchment, and do not arise as a process industrial effluent, municipal sewage effluent, deep mine or farm effluent discharge at a single point.

Dry swale

Shallow vegetated channel with filter in the base to convey surface runoff to the sewer network or infiltrate into the surrounding soils.

Embodied energy

The energy required to produce a service or product, eg during the manufacturing or processing stages. Can be related to CO₂ emissions.

Evapotranspiration

Process where moisture is lost from soil by evaporation of water and from transpiration by plants.

Exceedance

An event which has a result which exceeds a set target level, or in the case of drainage networks, a flow which exceeds the capacity of the sewers, causing surcharging and/or flooding.

Filter drains

A liner drain consisting of a trench filled with a permeable material, typically with a perforated pipe at the base to assist drainage. Can be used to convey water into a receiving drainage system or for infiltration.

Filter strips

A vegetated area of gently sloping ground designed to drain water evenly off impermeable areas and to filter out silt and other particulates.

Filtration

The removal of sediment or other particles from a liquid by passing it through a filter.

First flush

The initial runoff from an impermeable area or catchment subsequent to a rainfall event. As the runoff passes over the impermeable surface, it collects or dissolves pollutants and sediment, and this first portion of the runoff tends to be the most contaminated.

Footpath

*

Footway

Area at the side of carriageways for pedestrian movement.

Full bore

A pipe flowing at full capacity.

Geocellular

A plastic box structure situated below ground, used to attenuate runoff.

Geogrid

A plastic grid structure used to increase the strength and stability of soils and aggregates.

Geotextile

A permeable plastic fabric. It can be used to filter water and protect, reinforce, separate or drain soils.

Greenfield runoff

The rate of runoff which would occur from a site prior to any development, in its undisturbed state.

Groundwater recharge

The process of surface water passing downwards through the soils into the groundwater in the saturated zone.

Gulley

An opening in the road pavement to allow surface water to enter the drainage system, typically constructed from a prefabricated gully with metal grate cover.

Habitat

An environment where an organism or group of organisms live.

Hydrocarbons

Any chemical compound made up of hydrogen and carbon. A major pollutant formed by the engine as a by-product of combustion.

Hydrodynamic systems

Proprietary systems designed to remove floated debris, sediments and other associated pollutants from surface water, using fluid dynamics to separate the solids from liquids.

Impermeable membrane

An artificial plastic fabric which is impermeable to prevent infiltration.

Infiltration

The passage of surface water into the ground, or groundwater into a sewer.

Infiltration basins

A dry basin which is designed to promote infiltration of surface water into the ground.

Infiltration coefficient

This is a measure of the soil's permeability and determines the rate at which infiltration occurs.

Infiltration testing

Carried out during site investigation works to determine the permeability and the infiltration coefficient of the soil.

Infiltration blanket/trenches

A trench, typically filled with a permeable material, which is designed to promote infiltration of the surface water into the ground.

Local roads

Roads under the control of local roads authorities, such as general access roads, distributor roads and rural roads.

Metals

Pollutants which can be found on the road surface, such as lead, chromium, copper, nickel and zinc.

Microbial

Action of a bacterium causing disease or fermentation.

Moisture content

The amount of water present in the soil, usually given as a percentage.

Nutrients

Substances providing nourishment for living organisms, eg nitrogen & phosphorus.

Oil separators

Prefabricated proprietary system used to remove any spilled oils or hydrocarbons from surface runoff.

Peak flow

The maximum volume of water flowing in a watercourse or sewer over a certain period of time following a rainfall event.

Permeable concrete block paving

A surface which drains through voids between concrete blocks.

Ponds

A permanently wet depression designed to retain stormwater above the permanent pool and permit settlement of suspended solids and biological removal of pollutants.

Precipitation

The falling to earth of any form of water (rain, snow, hail, sleet or mist)

Rainfall intensity

The amount of rainfall occurring during a set unit of time, typically mm per hour.

Regional control

Surface water management for individual or multiple sites, normally in a balancing pond or wetland.

Residual risk

The risk still present after mitigation procedures have been implemented.

Retention time

The length of time that runoff is stored or detained to allow for settlement, or possibly biological action, to occur.

Return period

The frequency of an event occurring, eg a 100 year storm refers to the storm which occurs on average once every hundred years, or in other words its annual probability of exceedance is 1%.

Road Construction Consent

The process of gaining consent to construct roads, over which there is a public right of passage, to an agreed standard set by the local roads authority.

Road

*

Runoff

Water flow over the ground surface into the drainage system. This occurs when the ground is impermeable, saturated or the rainfall is particularly intense.

Sand filters

Above or below ground structures comprising single or multiple chambers with a sand bed as a filter medium providing treatment of runoff.

Scottish Water

Statutory corporation in Scotland that provides water and sewerage services.

Sedimentation

The process by which particles in suspension in a liquid settle to form a sediment.

Sediments

Particulate material that can be transported by water flow.

Sewer

A conduit taking surface water and foul sewage from roads, footways, buildings and hardstandings from two or more curtilages' and having a proper outfall, adopted by a water authority.

Silt traps

Often referred to as catchpits, they are chambers constructed within a piped system located at regular intervals not exceeding 100 m, at changes in direction and gradient and often prior to discharge of a piped system to a SUDS component. Provision is made for collection of silt by a sump which provides a permanent wet well.

Site control

Surface water management in a local area or site, eg picking up building roofs, car parks and other impermeable areas.

Source control

The control of surface water runoff at or close to the source.

Sub-base

A layer of unbound material laid onto the subgrade that provides a stable foundation for a pavement surface.

Sub catchments

A division of a catchment, to allow runoff to be managed as near to source as possible.

Subgrade

The material onto which the road pavement is constructed, usually natural in-situ, but may include capping layer.

Surcharge

Flow conditions where the hydraulic gradient is above the pipe soffit.

Surface course

The top layer of the road pavement which is in contact with the vehicular traffic.

Sustainable Urban Drainage Systems

A sequence of management practices and control techniques designed to drain surface water in a more sustainable way than some previous practices.

Swale

A shallow vegetated channel designed to convey and retain surface water runoff, and which can also allow for infiltration. The vegetation filters suspended solids.

Treatment volume

The proportion of the total runoff from impermeable areas which is required to be retained and treated to remove pollutants.

Trunk roads

Managed by Transport Scotland, a major road, usually connecting cities or large settlements, which is the recommended route for long-distance and freight traffic. Quite often dual carriageways or motorways.

Verge

Grassed margin bordering the carriageway and footways, but still located within the adoptable road extent.

Void space

The open spaces between gravel media which can be used as storage in permeable pavements and other treatment facilities.

Vortex separators

A proprietary SUDS system used for removal of suspended solids using hydrodynamic forces (see Hydrodynamic systems).

Waste Water Treatment Works

A facility to treat and make less contaminated domestic and/or industrial effluent.

Watercourse

Any natural or manmade channel which water flows through.

Wetlands

A flooded area in which the water is shallow enough for the growth of bottom rooted plants.

Acronyms

CAR	<i>Controlled Activities Regulations</i>
CBR	<i>California Bearing Ratio</i>
CDM	<i>Construction Design & Management</i>
CIRIA	<i>Construction Industry Research Information Association</i>
CSO	<i>Combined Sewer Overflow</i>
DMRB	<i>Design Manual for Roads and Bridges</i>
NIEA	<i>Northern Ireland Environment Agency</i>
NIHE	<i>Northern Ireland Housing Executive</i>
NIW	<i>Northern Ireland Water Ltd</i>
PAN76	<i>Planning Advice Note 76</i>
PEPG	<i>Planning and Environmental Policy Group</i>
RAMP	<i>Roads Asset Management Plan</i>
RCC	<i>Road Construction Consent</i>
RoSPA	<i>The Royal Society for the Prevention of Accidents</i>
SEPA	<i>Scottish Environment Protection Agency</i>
SFRA	<i>Strategic Flood Risk Assessment</i>
SNIFFER	<i>Scotland & Northern Ireland Forum For Environmental Research</i>
SPP	<i>Scottish Planning Policy</i>
SUDS	<i>Sustainable Urban Drainage Systems</i>
SWMP	<i>Surface Water Management Plan</i>
TRRL	<i>Transport and Road Research Laboratory</i>

UID	<i>Unsatisfactory Intermittent Discharge</i>
WEWS Act	<i>Water Environment and Water Services (Scotland) Act 2003</i>
WLC	<i>Whole Life Costing</i>
WWTW	<i>Waste Water Treatment Works</i>

Application Forms

Click on the form titles below to access editable PDF versions for your own use.

- [Quality Audit Summary Report Template](#) 
- [CC1 - Construction Consent Application](#) 
- [CC2 - Docquets of Service](#) 
- [CC3 - Notice of Service](#) 
- [CC6 - Adoption Certificate](#) 
- [CC8 - Carriageway Design Certificate](#) 
- [CC9 - Construction Consent Checklist](#) 
- [DCC1 - Design Certificate for Road Lighting](#) 
- [DCC2 - Construction Details and Visual Inspection Certificate](#) 
- [DCC3 - Electrical Inspection and Test Certificate](#) 

Local Authority Variations

Click on the form titles below to access each local authority's variations. The 'Master' form is an editable PDF which can be completed with your own details.

* NB no variations intimated at this stage

[Master Local Authority Variation Form](#) 

[Aberdeen City](#) 

[Aberdeenshire](#)*

[Angus](#)*

[Argyll & Bute](#)*

[Clackmannanshire](#)*

[Dumfries & Galloway](#) 

[Dundee City](#) 

[East Ayrshire](#)*

[East Dunbartonshire](#)*

[East Lothian](#) 

[East Renfrewshire](#)*

[Edinburgh](#)*

[Falkirk](#) 

[Fife](#)*

[Glasgow](#) 

[Highland](#) 

[Inverclyde](#)*

[Midlothian](#)*

[Moray](#) 

[North Ayrshire](#)*

[North Lanarkshire](#)*

[Orkney](#)*

[Perth & Kinross](#)*

[Renfrewshire](#) 

[Scottish Borders](#)*

[Shetland](#)*

[South Ayrshire](#)*

[South Lanarkshire](#) 

[Stirling](#)*

[West Lothian](#)*

[West Dunbartonshire](#)*

[Western Isles](#)*